

# Interconnect

connectors, test points, terminals

## Interconnect

Oxley is an established designer and manufacturer of high quality electronic components.

We meet customer requirements with a complete range of standard electrical components for interconnection, as well as offering clients custom design and manufacturing facilities for non-standard solutions.

We offer a wide range of surface mount and through hole interconnect products off-the-shelf for use in electronic applications:

- Surface Mount PCB Test Points
- Through Hole PCB Test Points
- Through Hole PCB Connectors
- Chassis Mounted Insulated Terminals and Feedthroughs
- Chassis Mounted and In Line Insulated Plugs and Sockets
- Custom Interconnection

Oxley Interconnect parts can be supplied in a wide variety of plating ROHS compliant finishes to various standards (the tin lead range of components do not meet ROHS compliance).

In addition, we offer a sub contract precision machining service to produce tight toleranced turned parts including those made from speciality materials such as Alumel and Chromel.

In terms of design, production and Quality Assurance procedures, the Oxley high standard has been recognised by National Approvals for manufacture and research to BS EN ISO 9001: 2000, BS9000 and IECQ-CECC.

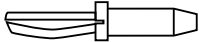
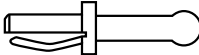
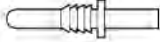
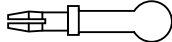
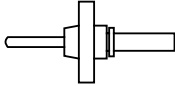
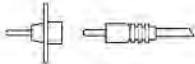
Types	Features	Page
<p><b>SMOX</b> Surface Mount Test Points</p> 	<ul style="list-style-type: none"> <li>• Available either loose or taped and reeled</li> <li>• Requires minimum pad size of only 2mm diameter</li> <li>• Unique retention mechanism prevents damage to PCB during connection/disconnection of socket</li> </ul>	3
<p><b>KINKY PIN PTH</b> Connectors</p> 	<ul style="list-style-type: none"> <li>• Designed for plated through hole applications</li> <li>• Insertion tools available for hand and semi-automatic insertion</li> <li>• Custom styles available</li> </ul>	5
<p><b>KINKY PIN PTH</b> SNAPLOX</p> 	<ul style="list-style-type: none"> <li>• Designed for plated through hole applications</li> <li>• Unique retention mechanism allows rapid connection/disconnection</li> <li>• Custom styles available</li> </ul>	7
<p><b>SNALE</b> Printed Circuit Connectors</p> 	<ul style="list-style-type: none"> <li>• Self-retention mechanism provides high retention and rigidity</li> <li>• Custom styles available</li> <li>• Snaplox, holed and test-point styles available</li> </ul>	9
<p><b>SNALE SNAPLOX</b> Printed Circuit Test Point</p> 	<ul style="list-style-type: none"> <li>• Award winning design allows rapid connection/disconnection</li> <li>• Self-retaining and straight shank designs available</li> <li>• Suitable for chassis, PCB and ceramic hybrids</li> </ul>	13
<p><b>BARBCONE LOCK</b> PTFE Insulated Terminals</p> 	<ul style="list-style-type: none"> <li>• Insulated terminal designed for mounting on chassis/frameworks</li> <li>• Hermetically sealed versions available as standard</li> <li>• Hand assembly tools available for ease of insertion</li> </ul>	17
<p><b>BARBCONE LOCK</b> Plugs and Sockets</p> 	<ul style="list-style-type: none"> <li>• PCB edge mounted variants available for card-rack systems</li> <li>• Colour options for PTFE Bush</li> <li>• In-line and stackable styles to reduce real estate</li> <li>• Ease of assembly to increase production</li> </ul>	23

Surface mount ball and socket test point

**[Key Characteristics**

**Functionality**

- Low contact resistance
- Unique retention mechanism
- Pick and place compatibility

**Resilient**

- Gold plated, other finishes available
- Kinematic design
- -55 to +125° C

**Adaptable**

- Available loose or on tape and reel
- Hand or automatic assembly



SMOX is a unique test terminal which provides accurate line tests in PCB assembly. Supplied loose or on tape and reel for ease of assembly, its unique retention mechanism enhances reliability through low stress contact.

Due to the unique nature of the SMOX connection system, it represents the only surface mount ball and socket test point available on the market with a specially designed socket for easy low contact resistance and gentle detachment.

Requiring a minimum pad size of only 2 millimetres (0.080”), and being a single pole device, the SMOX can be placed accurately by any pick and place machine in even the most congested designs.

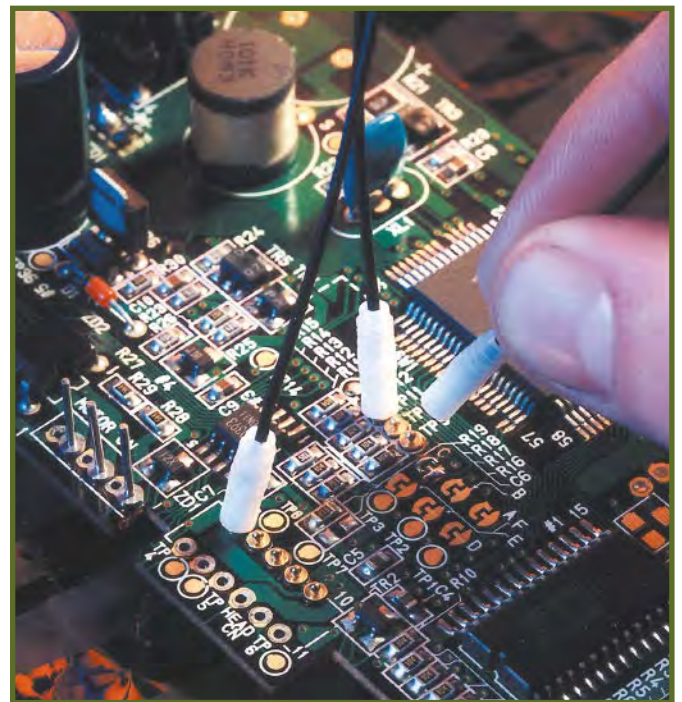

**Typical Soldering Profiles - SMOX to PCB**

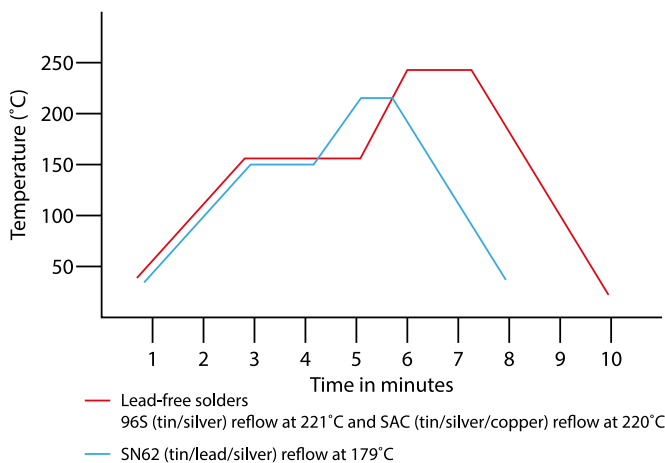

**HT Type SMOX** - For use with ROHS compliant lead-free solders (high temperature). Example: 96S (re-flow at 220°C).

**Standard Type SMOX** - For use with tin lead solders (lower temperature). Example: 60/40, SN62 (re-flow at 179°C).



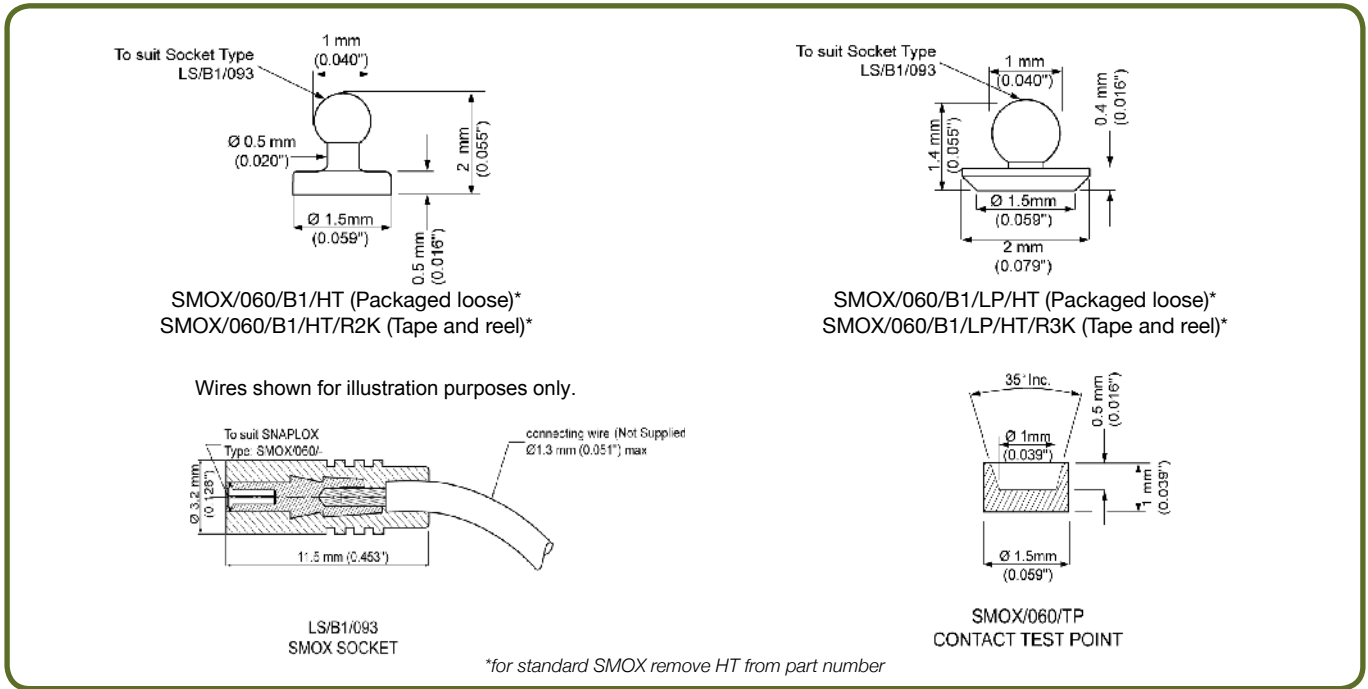

## Technical Information

Test Point and Socket Body	Copper Alloy
Insulation	High Dispersion PTFE
Test Point Finish	Gold (Options Palladium, Silver, Nickel, Tin Lead)
Socket Finish	Silver
Solderability	Exceeds Requirements of BS2011 (IEC 68) Test T MIL-STD-202 Method 208
Maximum Contact Resistance	2 milliOhms
Socket Insulation Resistance	10,000 MegaOhms minimum
Typical Retention Force	0.2Kg (Angles < 60° or ± 30°) Off Perpendicular
Typical Retention Torque	200gcm (Angles > 30° or Perpendicular)
Assembly Tools Socket Assembly	AT1/KP18 and AT1/KP19
Tape	4mm pitch 8mm wide
Reel Sizes SMOX/060/B1/LP/HT/R3K (7 inch)	3000 components
Reel Sizes SMOX/060/B1/HT/R2K (7 inch)	2000 components



## Kinked Retention Plated Through Hole Connector with Solder Posts

### [Key Characteristics

#### Functionality

- Plated Through Hole Applications (PTH)
- Unique kinked retention mechanism
- Design enhances solderability
- Low insertion force

#### Resilient

- -55 to +125° C

#### Adaptable

- Hand and semi automatic insertion
- Wide range of diameters



Kinky Pins were designed specifically to meet the demands of plated through hole (PTH) technology introduced in printed circuit boards. They tend to be used with flexi-circuit terminations and as solder terminals, connectors and in multiway pin arrays.

They use a unique kinked retention mechanism which gives a fit in the PTH that is unsurpassed. The kinked leg provides a tight non-aggressive spring loaded fit whilst the straight leg ensures the pin is kept perpendicular to the PCB prior to soldering.

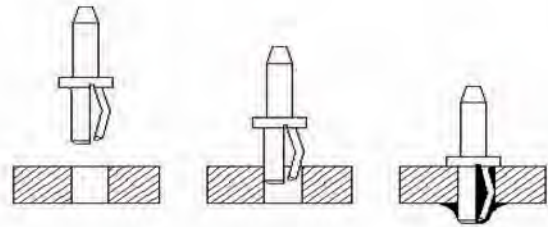

### [Technical Information

Minimum Pitch using Assembly Tool	2.5mm (0.098") 028,030,040 Series 3.0mm (0.118") 050,060 Series
Pin	Copper Alloy with Tin Lead Finish (option Gold, Silver, Tin)
Solderability	Exceeds Requirements of BS2011 (IEC 68) Test T
Assembly Tools Socket Assembly	AT1/KP1 (-/30P/KP2, -/30P/KP2/L) AT1/KP2 (028-040/T/KP2) AT1/KP3 (-/10P/30P/KP2/L, 050-060/T/KP2)
Line Socket	30/LS/093 - to suit -/30P/KP2 and -/30P/KP2/L

## [Ordering Information

	Mounting Hole Diameter	Shoulder Diameter 'A'
028/---	0.68mm (0.027") to 0.84mm (0.033")	1.6mm (0.063")
030/---	0.81mm (0.032") to 0.96mm (0.038")	1.6mm (0.063")
040/---	0.96mm (0.038") to 1.12mm (0.044")	1.6mm (0.063")
050/---	1.21mm (0.048") to 1.37mm (0.054")	2.4mm (0.094")
060/---	1.50mm (0.059") to 1.65mm (0.065")	2.4mm (0.094")

EXAMPLE: 028/30P/KP2/L

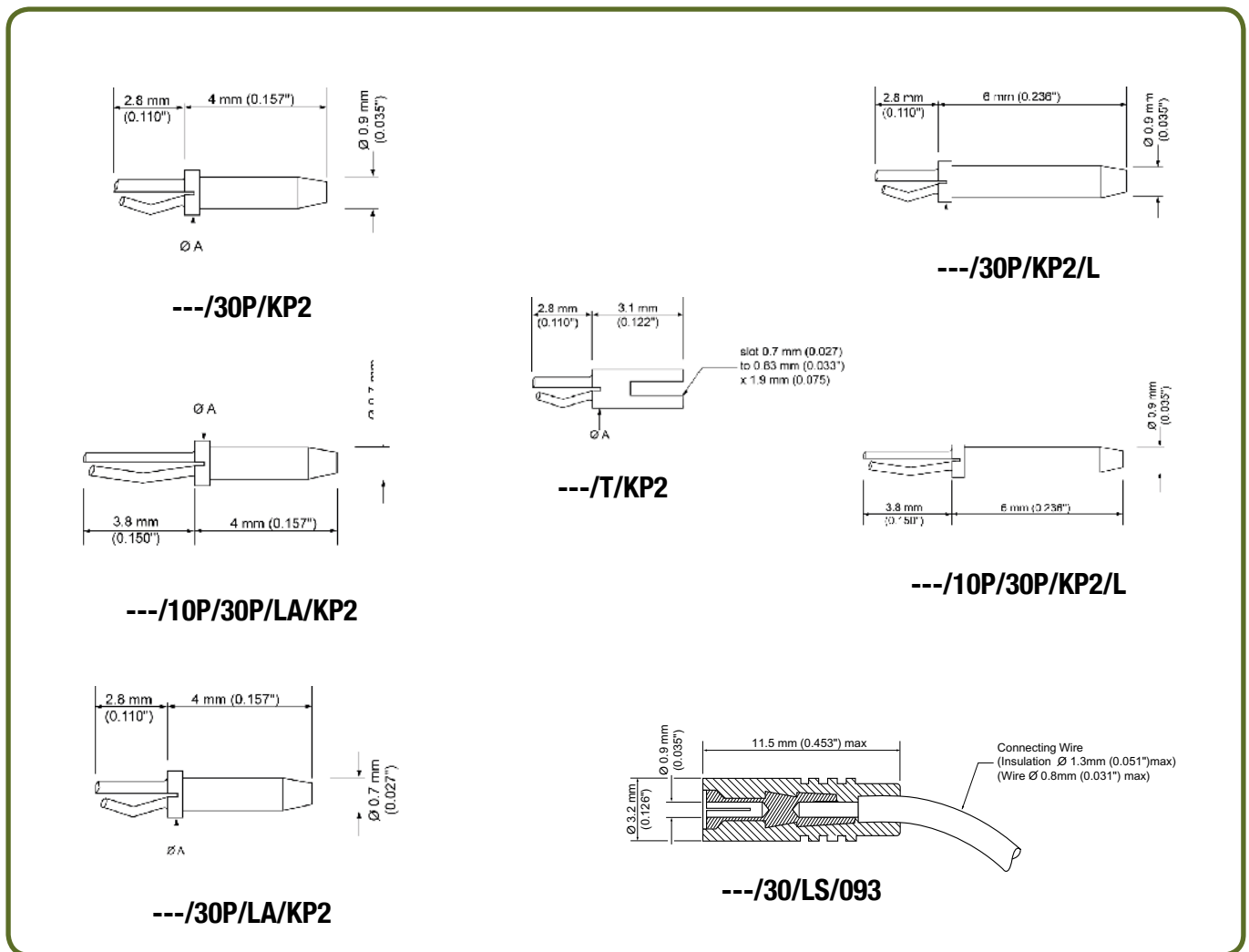



## Kinked Retention Plated Through Hole Connector with Ball Socket

### [Key Characteristics

#### Functionality

- Plated Through Hole Applications (PTH)
- Unique kinked retention mechanism
- Design enhances solderability
- Low insertion force

#### Resilient

- Gold plated
- -55 to +125° C

#### Adaptable

- Hand and semi automatic insertion
- Wide range of diameters

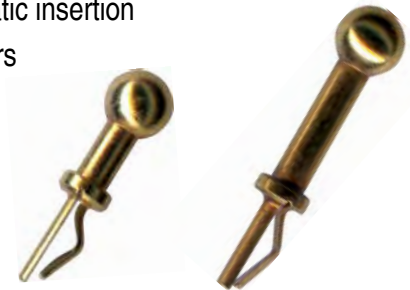

Kinky Pins were designed specifically to meet the demands of plated through hole (PTH) technology introduced in printed circuit boards.

The Snaplox® concept enables highly accurate testing to be done whilst reducing the risk of board damage. This is due to the unique ball and socket arrangement which provides 8 points of low resistance contact through a 60° connection angle.

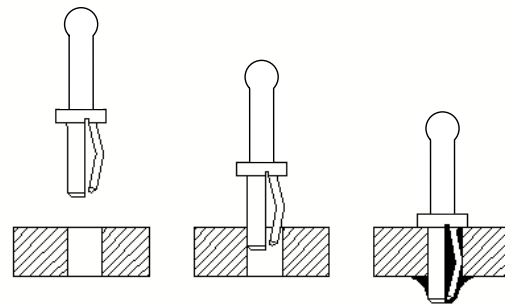

### [Technical Information

Minimum Pitch using Assembly Tool	2.5mm (0.098") 028,030,040 Series 3.0mm (0.118") 050,060 Series
Pin	Copper Alloy with Gold Finish (option Tin Lead)
Socket	Brass with Silver Finish & High Dispersion Grade PTFE
Solderability	Exceeds Requirements of BS2011 (IEC 68) Test T MIL-STD-202 Method 208
Contact Resistance (with socket)	<5 milliOhms
Socket Insulation Resistance	10,000 MegaOhms minimum
Typical Retention Force	2kg (Angles <30°) off perpendicular
Typical Retention Torque	200 gcm (Angles>30° or perpendicular)
Assembly Tools Socket Assembly	AT1/KP2



## [Ordering Information

	Mounting Hole Diameter	Shoulder Diameter 'A'
028/---	0.68mm (0.027") to 0.84mm (0.033")	1.6mm (0.063")
030/---	0.81mm (0.032") to 0.96mm (0.038")	1.6mm (0.063")
040/---	0.96mm (0.038") to 1.12mm (0.044")	1.6mm (0.063")
050/---	1.21mm (0.048") to 1.37mm (0.054")	2.4mm (0.094")
060/---	1.50mm (0.059") to 1.65mm (0.065")	2.4mm (0.094")

EXAMPLE: 028/SO/BK2F

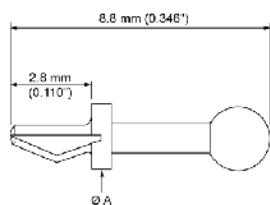

---/SO/BK2F

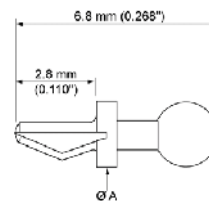

---/SO/BK2P

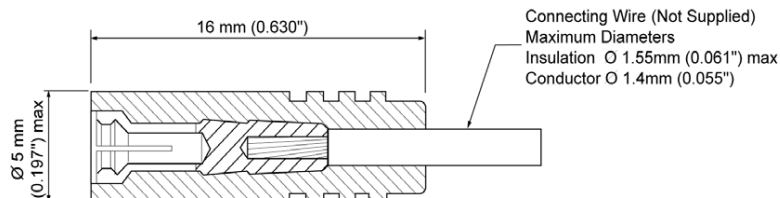

**LS/B2/156**  
(to suit all 2mm Snaplox)



Knurled/Barbed Retention Non-Plated Through Hole Connectors with Solder Posts

**[Key Characteristics**

**Functionality**

- Self retaining interference fit
- Non-plated through hole applications
- Low insertion force

**Resilient**

- Serrated outline prevents rotation

**Adaptable**

- Various lengths and widths
- Bespoke designs available



The use of Snale Pins has been widely established in the commercial and military electronics market worldwide as the definitive terminal pin for use with non-plated through hole PCB's and chassis.

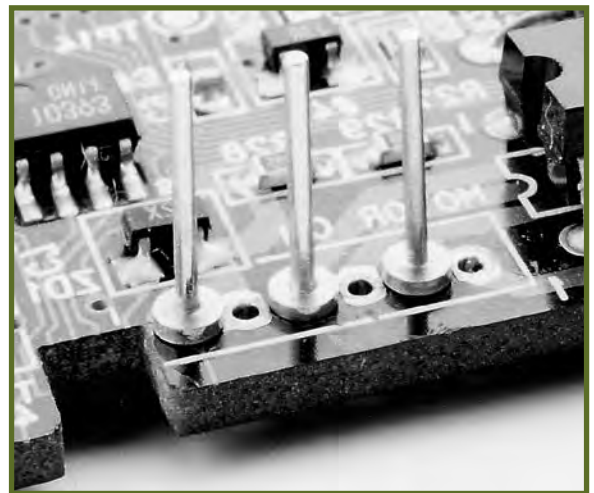

**[Technical Information**

Pin Material	Brass
Pin Finish	Tin Lead (optional gold and palladium)
Contact Resistance	<2 mOhms
Solderability	Exceeds Requirements of BS2011 (IEC 68) Test T MIL-STD-202 Method 208

## [Series Information

	SERIES	
	040	050
<b>Mounting Hole Diameter</b>	1.02mm ± 0.04mm (0.040" ± 0.0016")	1.31mm ± 0.06mm (0.052" ± 0.002")
<b>Board Thickness</b>	0.8mm (0.031") min	0.8mm (0.031") min
<b>Hole Diameter</b> (Copper Clad paper phenolic 1.6mm (0.063") thick)	1.05mm (0.042") 1.02mm (0.04") 0.98mm (0.039")	1.32mm (0.052") 1.30mm (0.051") 1.25mm (0.049")
<b>Retention Force (kg)</b>	5,6,8	4,5,6
<b>Assembly Tools</b>	SN/040/LT - A1/10 SN/040/RP - AT1/13 SN/040/RP/H - AT2/30/A SN/040/SO - AT1/10	050/- -/AT1/09 SN/050/30P - AT1/18 SN/050/L & XL - 1/11 SN/050/LT (&SO) - AT1/10 SN/050/L/C - AT1/02 SN/050/PG - AT1/05 SN/050/RP - AT1/12 SN/050/RP - - AT1/01 SN/050/RP/H - AT2/02/A SN/050/T - AT1/06

**[Part & Ordering Information**

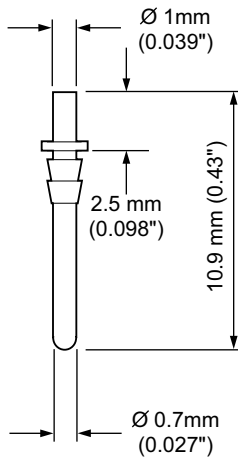

**SN/040/LTU**

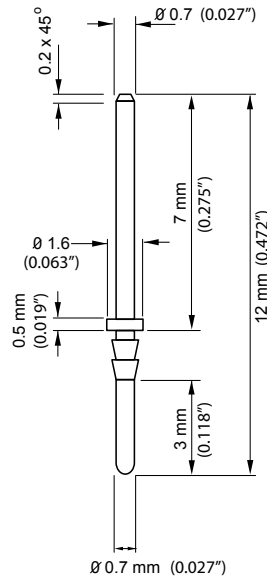

**SN/040/LT/BA**

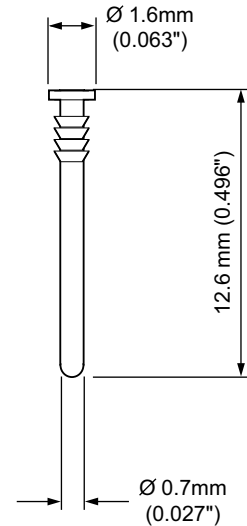

**SN/040/RPL**

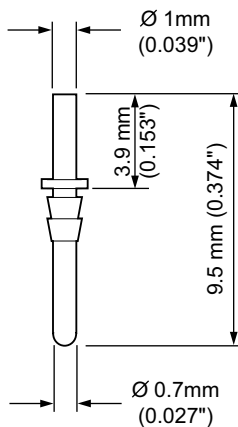

**SN/040/LT**

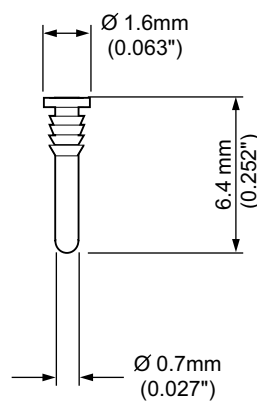

**SN/040/RP**

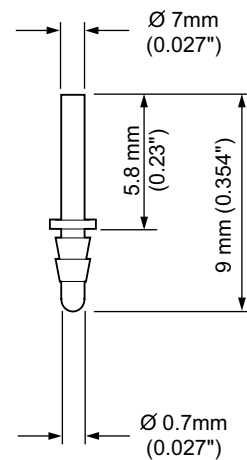

**SN/040/LT/D**

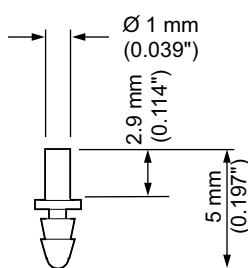

**SN/040/SO/PG**

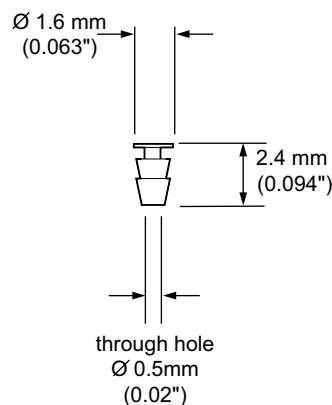

**SN/040/RP/H**

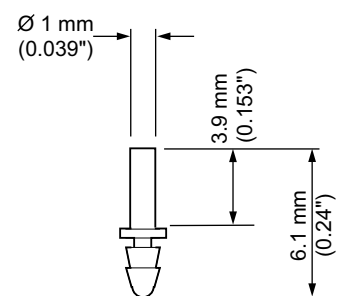

**SN/040/SO**

### [Part & Ordering Information

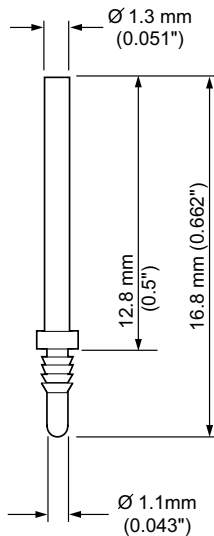

**SN/050/L/C**

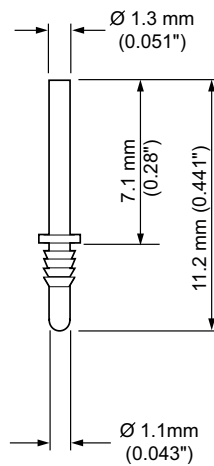

**SN/050/L**

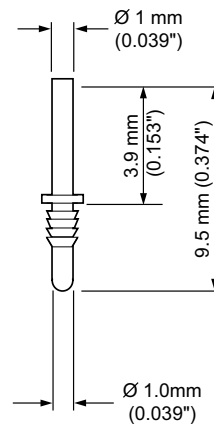

**SN/050/LT**

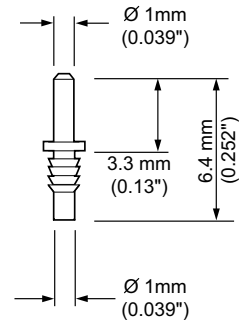

**SN/050/PG**

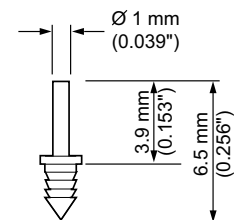

**SN/050/SO**

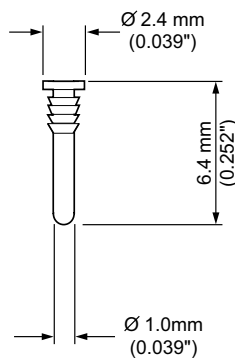

**SN/050/RP**

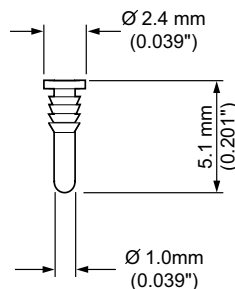

**SN/050/RP/BA**

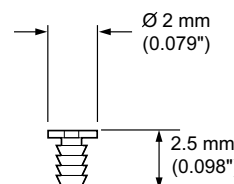

**SN/050/30/P**

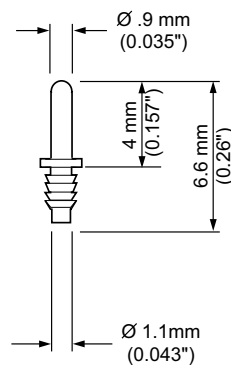

**SN/050/30/P**

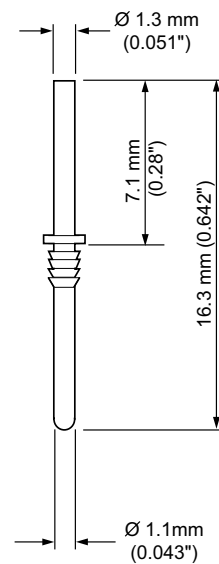

**SN/050/XL**

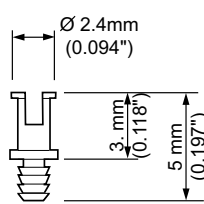

**SN/050/T**

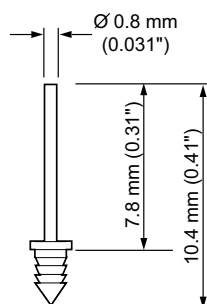

**SN/050/S0/LP**



\*This does not include tin lead finishes



Knurled/Barbed Retention Non Plated Through Hole Connectors with Ball Socket

## [Key Characteristics

### Functionality

- Self retaining interference fit
- For single & double sided PCBs
- Low insertion force
- Unique retention mechanism

### Resilient

- Gold plated
- -55 to +125° C

### Adaptable

- Various lengths
- Bespoke designs available



The use of Snale Pins has been widely established in the commercial and military electronics market worldwide as the definitive terminal pin for use with non-plated through hole PCB's and chassis.

The Snaplox® concept enables highly accurate testing to be done whilst reducing the risk of board damage. This is due to the unique ball and socket arrangement which provides 8 points of low resistance contact through a 60° connection angle.



## [Technical Information

Pin	Brass with Gold Finish (option Tin Lead, Palladium)
Socket	Copper Alloy with Silver Finish & High Dispersion Grade PTFE
Solderability	Exceeds Requirements of BS2011 (IEC 68) Test T
Maximum Contact Resistance (with socket)	2 milliOhms
Socket Insulation Resistance	10,000 MegaOhms minimum
Typical Retention Force	2kg (Angles <30°) off perpendicular
Typical Retention Torque	200 gcm (Angles>30° or perpendicular)
Assembly Tools Socket Assembly - Line Plug	AT2/05 or ATS3/05, AT1/09 (Line Plug)
Assembly Tools Pin to PCB	AT1/09

## [Series Information

Type No.	Mounting Hole Diameter	PCB Thickness	Shoulder diameter $\varnothing A$
030/SO/B2 or BF	0.81 mm (0.032") - 0.92 mm (0.036")	1.65 mm (0.065") - 1.85 mm (0.073")	1.6 mm (0.063")
030/SO/BF	0.81 mm (0.032") - 0.92 mm (0.036")	1.65 mm (0.065") - 1.85 mm (0.073")	1.6 mm (0.063")
030/SO/BCS/-	0.81 mm (0.032") - 0.92 mm (0.036")	1.65 mm (0.065") - 1.85 mm (0.073")	1.6 mm (0.063")
050/-	1.25 mm (0.049") - 1.40 mm (0.055")	1.4 mm (0.055") min	2.4 mm (0.094")
050/B2/RS	1.25 mm (0.049") - 1.37 mm (0.054")	N/A	2.4 mm (0.094")

## [Part & Ordering Information

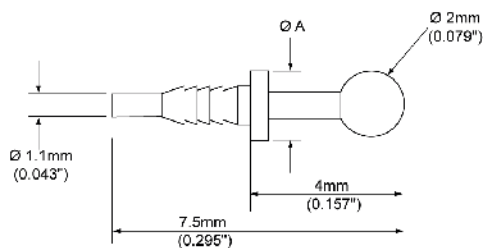

**050/SOX/B2**

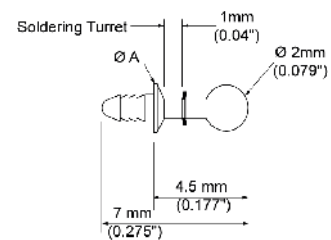

**050/SO/BST**

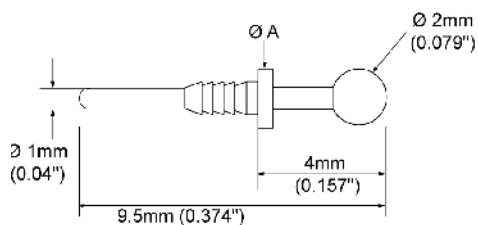

**050/LT/B2**

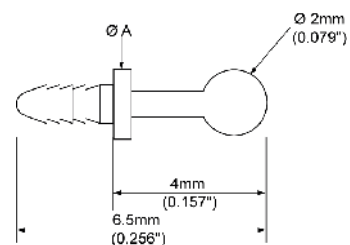

**050/SO/B2**



**[Part & Ordering Information**

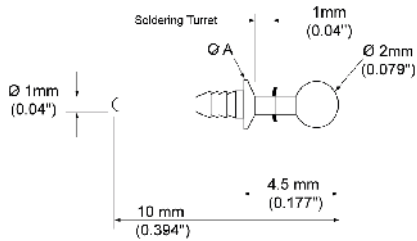

**050/LT/BST**

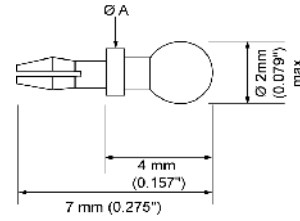

**030/SO/BCS/P**

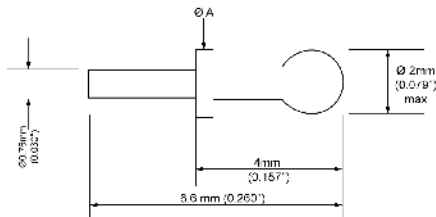

**030/SO/B2**

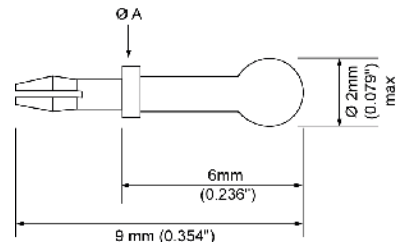

**030/SO/BCS/F**

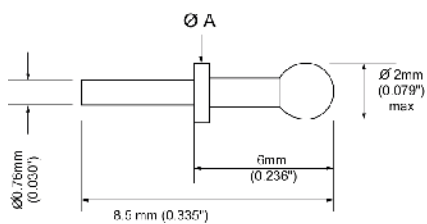

**030/SO/BF**

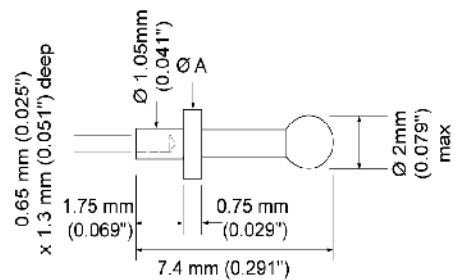

**050/B2/RS**

## [Part & Ordering Information

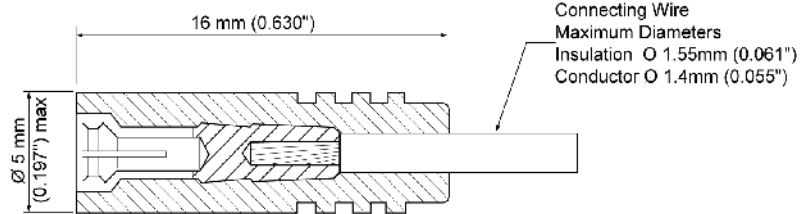

### LS/B2/156

wire shown for illustration purposes only

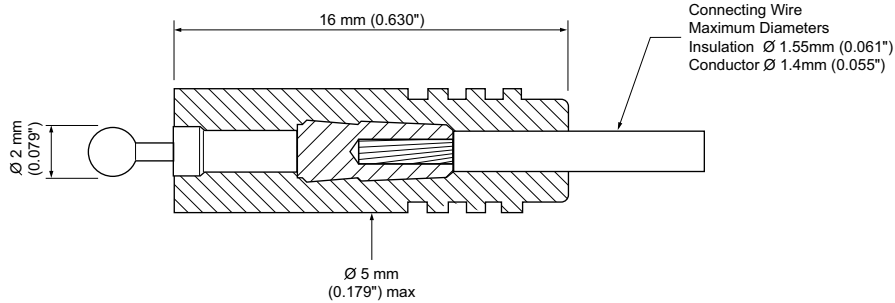

### LP/B2/156

wire shown for illustration purposes only



### [Key Characteristics

#### Functionality

- Rapid assembly
- Self retaining

#### Resilient

- High insulation resistance
- Pressure Sealing
- Low capacitance

#### Applications

- Chassis mounting insulated stand-off
- Pressure bulkhead feedthrough sealing



Oxley Developments designed the Barb Cone Lock® technology. They are constructed from PTFE and have an elastic property which allows the barbed metal spill to lock itself in place by gently expanding the PTFE underneath the chassis during insertion. This ensures a long life, stable fixing in the chassis which is a fundamental part of the product's success.

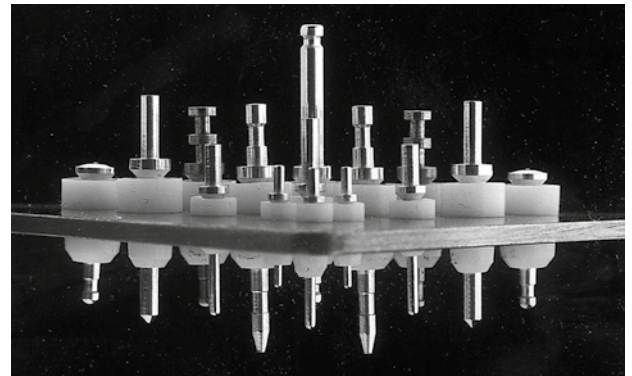

### [Technical Information

Bush	High Dispersion PTFE
Spill Material	Brass
Spill Finish	Silver (other options available on request)
Bush Colours	White, Black, Red
Insulation Resistance	>2 x 10 <sup>6</sup> MOhms
CEEL Options Leakage Rate	Less than 10 <sup>-3</sup> µl/sec of Helium. 1 atmosphere differential pressure (15lb/in <sup>2</sup> ) at 20°C, equivalent to a depth of 10m in sea water

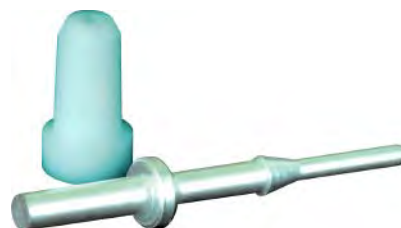

## Series Information

Range →	62	78	93	125	136	156	187	250	CEEL
Mounting Hole Diameter	1.57mm (0.062")	1.98mm (0.078")	2.36mm (0.093")	3.18mm (0.125")	3.45mm (0.136")	3.96mm (0.093")	4.75mm (0.187")	6.35mm (0.250")	156 3.96mm (0.156") 250 6.35mm (0.250")
Chassis Thickness	0.56mm (0.022") /0.71mm (0.028")	1.2mm (0.047") /1.6mm (0.062")	2.03mm (0.08"0) /2.3mm (0.09")	1.2mm (0.047") /1.6mm (0.063")	1.2mm (0.047") /1.6mm (0.063")	1.2mm (0.047") /1.6mm (0.063")	1.6mm (0.062") /2.3mm (0.09")	2.3mm (0.09") /3.2mm (0.126")	2.4mm (0.094") /3.2mm (0.126")
Max Outside Bush Dia	2.7mm (0.1")	2.8mm (0.11")	3.6mm (0.14")	5.7mm (0.224")	4.7mm (0.185")	5.4mm (0.213")	7.4mm (0.291")	8.9mm (0.350")	
Current Rating	0.5A	1.0A	1.0A	5A	5A	5A	5A	15A	
Rated Voltage at Sea Level	0.5Kv	0.5Kv	1.5Kv	2Kv	2Kv	3Kv	5Kv	4Kv	
Proof Voltage at Sea Level	2.5Kv	2.5Kv	4.5Kv	5.5Kv	5.5Kv	7.5Kv	11.5Kv	9.5Kv	
Capacitance max	0.5pF	0.5pF	0.8pF	0.8pF	0.8pF	0.8pF	1.0pF	1.7pF	
Assembly Tool	AT1/01	AT1/01	AT1/11	AT1/05	136/SO - AT1/11 136/LP - AT1/17	AT1/02	AT1/06	AT1/07	156-/CEEL AT1/05 250-/CEEL AT1/07

**[Ordering Information & Dimensions**

**062 Range**

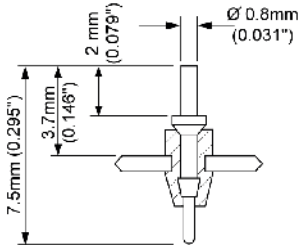

**062**

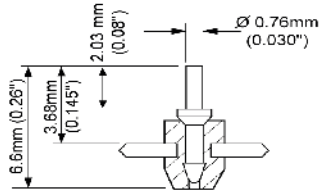

**062/S0**

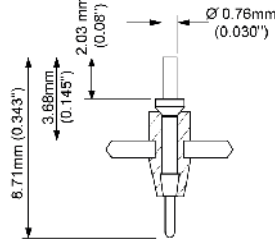

**078**

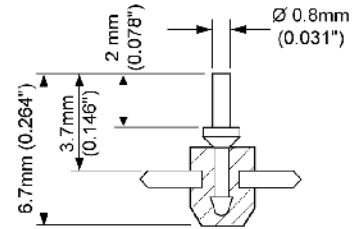

**078/S0**

**078 Range**

**093 Range**

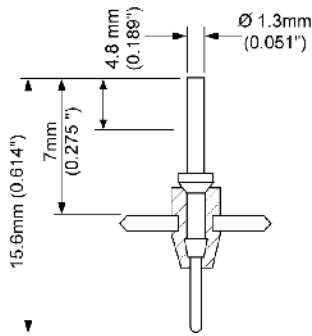

**093/16P**

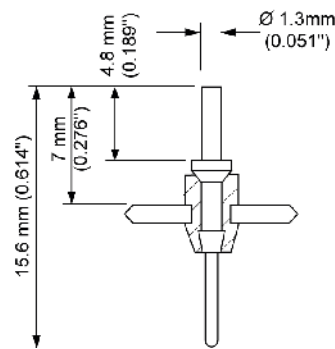

**093/093**

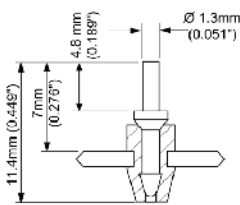

**093/S0/16P**

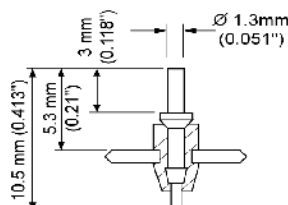

**093/20P**

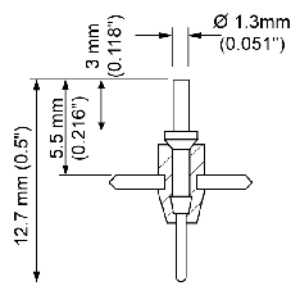

**093/18P**

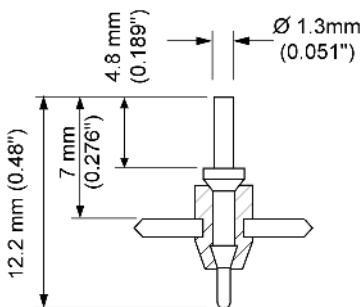

**093/20/LP**

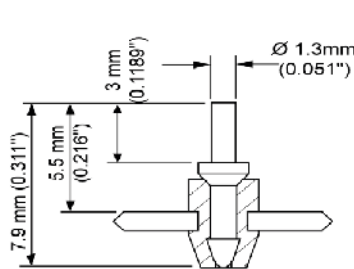

**093/S0/18P**

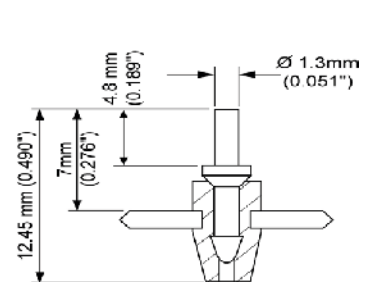

**093/093/S0**

## [Ordering Information & Dimensions

### 125 Range

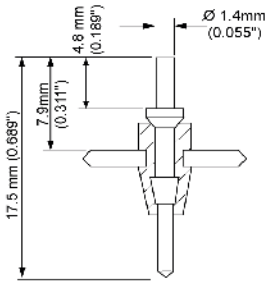

**125/LP**

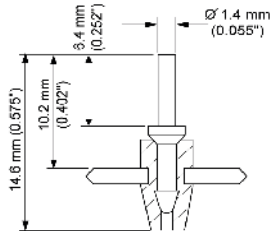

**125/SO/LP**

### 136 Range

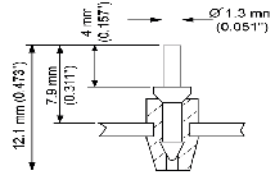

**136/SO**

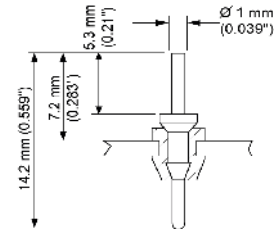

**136/LP**

### 187 Range

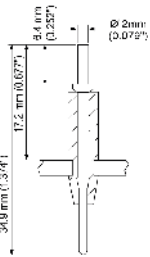

**187**

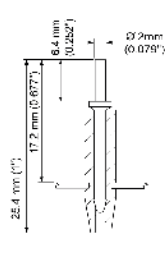

**187/SO**

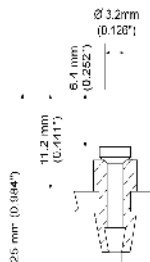

**250**

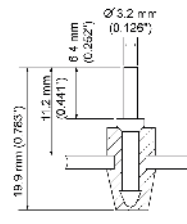

**250/SO**

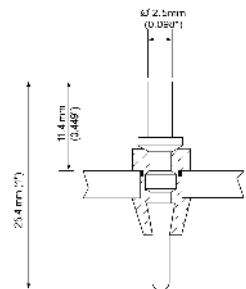

**CEEL**  
**250/10P/CEEL**

### 156 Range

#### CEEL Improved Environmental Seal

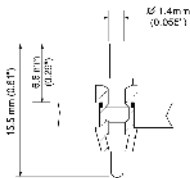

**156/10P/CEEL**

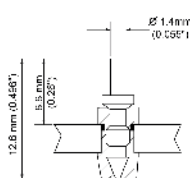

**156/SO/10P/CEEL**

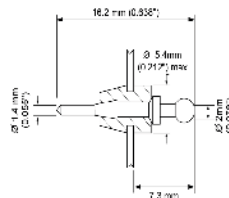

**156/LP/B2**

#### Snaplox

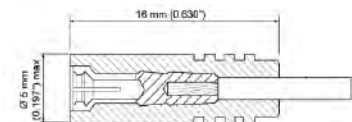

**LS/B2/156**  
to suit 156/LP/B2

**[Ordering Information & Dimensions**

**156 Range**

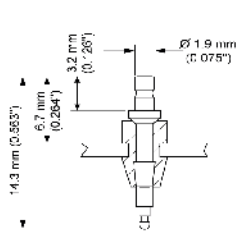

**156**

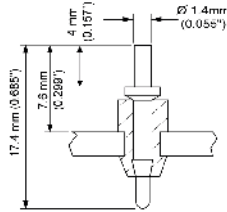

**156/10P**

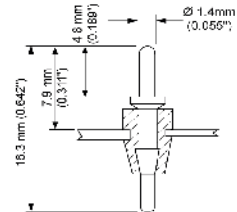

**156/LPR**

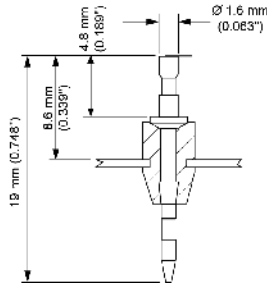

**156/E**

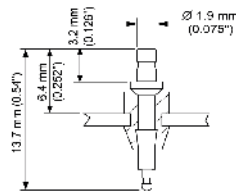

**156/20**

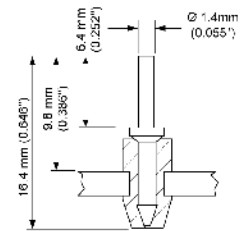

**156/S0/10P**

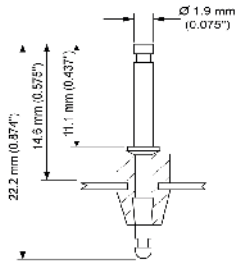

**156/L**

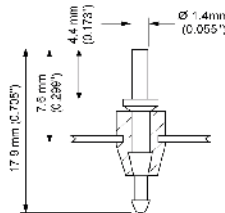

**156/AT**

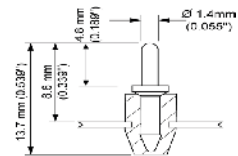

**156/S0/LPR**



[Ordering Information & Dimensions

156 Range (continued)

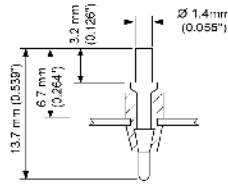

156/20P

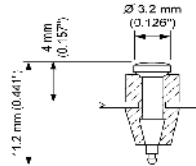

156/M

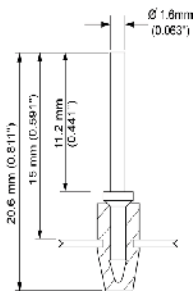

156/SO/XL

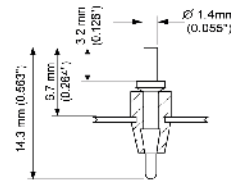

156/P

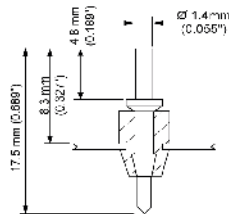

156/LP

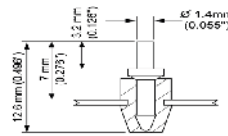

156/SO/P



### [Key Characteristics

#### Functionality

- Simple economic assembly
- Self retaining
- Low capacitance

#### Resilient

- High Reliability
- Low contact resistance
- High insulation resistance

#### Applications

- Line and chassis mounting
- Stackable
- PCB edge variations



Using the same technology as the Barb Cone Lock® Insulated Terminals, this product range utilise High Dispersion Grade PTFE for insulation and reliability. The range includes chassis mounting plugs and sockets, line plugs and sockets and multiway edge mounting sockets all in a range of diameters from 0.5 mm to 4 mm with current ratings from 1 to 15 Amps. Typical applications are for test equipment and card rack systems in the military, aerospace and nuclear industries and for high voltage applications up to 4 kV.

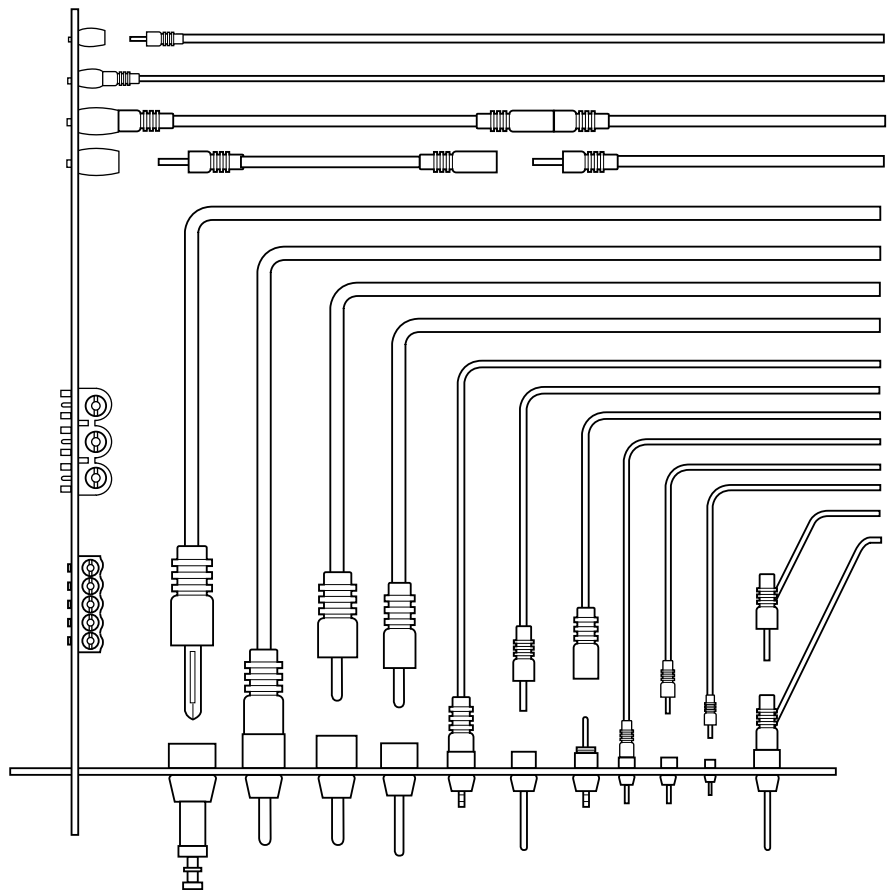

### [Technical Information

Material	Copper Alloy
Plug Finish	Gold
Socket Finish	Silver

## Series Information

Range →	0.55	2-	4-	30	40	50	60	100
Mounting Hole Diameter	2.0mm (0.079")	6.0mm (0.236")	8.0mm (0.312")	2.4mm (0.093")	4.0mm (0.156")	4.0mm (0.156")	4.0mm (0.156")	6.4mm (0.250")
Nominal Diameter plug & socket	0.55mm (0.022")	2mm (0.079")	4.0mm (0.157")	0.9mm (0.035")	1.2mm (0.040")	1.27mm (0.050")	1.52mm (0.060")	2.54mm (0.100")
Max Wire Diameter	0.65mm (0.025")	2.6mm (0.1")	2.64mm (0.104")	0.8mm (0.31")	1.6mm (0.063")	1.6mm (0.063")	1.6mm (0.063")	3.1mm (0.122")
Conductor	1.15mm (0.045")	3.7mm (0.146")	3.8mm (0.15")	1.2mm (0.047")	2.00mm (0.079")	2.00mm (0.079")	2.00mm (0.079")	4.1mm (0.161")
Insulator				30S/093/V, 30S/093/VL: N/A	-P/156: AT 1/17 & ATS 3/05	-P/156: AT 1/18 & ATS 3/05	--P/156: AT 1/19 & ATS 3/05	100P-250: AT 1/20 & ATS 3/16
Assembly Tools	P/2 – AT1/23	2P/6 – AT1/22 & ATS 3/16	4P/8 – n/a	30S/093: AT 2/12	-FP/156: AT 1/17 --LS/156: AT 2/08 & ATS 3/05	P/156/S: AT 1/18 ---LS/156: AT 2/07 & ATS 3/05	-/: AT 2/09	100 FP/250: AT 1/20
Resistance to Axial Pull:	S/2 – AT2/15	2S/6 – AT2/13	4S/8 – AT2/13	30S/093, 30LS/093: AT 1/21 & ATS 3/08	-/: AT 2/11	-/: AT 2/09	FP/156: AT 1/19 -LS/156: AT 2/06 & ATS 3/05	100LS/250: AT 2/04 & ATS 3/16
Capacitance to Chassis (max.):	1.8kgf (4lbf)	15kgf (30lbf)	15kgf (30lbf)	2.3kgf (5lbf)	6.8 kgf (15 lbf)	6.8 kgf (15 lbf)	100S/250: AT 2/05	15kgf (30lbf)
Current Rating:	0.5pF	2.0pF	2.0pF	1.0pF	1.0 pF	1.0 pF	2.0pF	2.0pF
Rated Voltage:	1A	5A	15A	3A	3A	3A	5A	5A
	0.5kV d.c.	2 kV d.c.	2 kV d.c.	2 kV d.c.	2 kV d.c.	2 kV d.c.	4 kV d.c.	4 kV d.c.

**[Ordering Information & Dimensions**

**0.55-, 2-, 4- Range**

**0.55P/2**

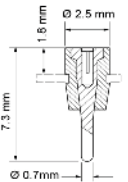
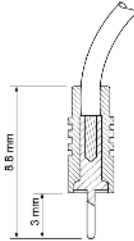

**0.55S/2**

Chassis Thickness  
0.9 mm (0.036")/  
1.2 mm (0.048")

**2P/6**

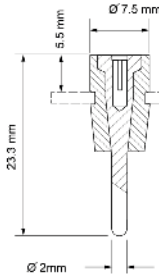
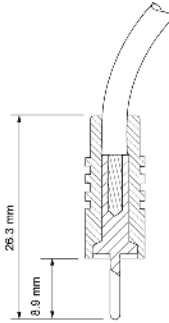

**2S/6**

Chassis Thickness  
1.6 mm (0.064")/  
2.3 mm (0.092")

**4P/8**

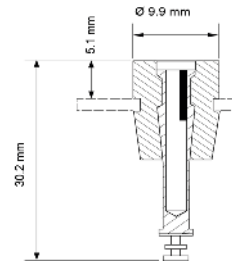
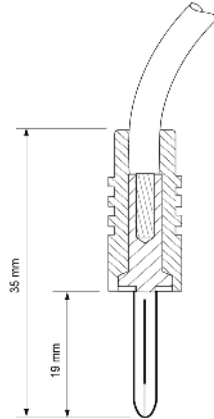

**4S/8**

Chassis Thickness  
1.6 mm (0.064")/  
3.2 mm (0.128")

**30 Range**

**30P/093**

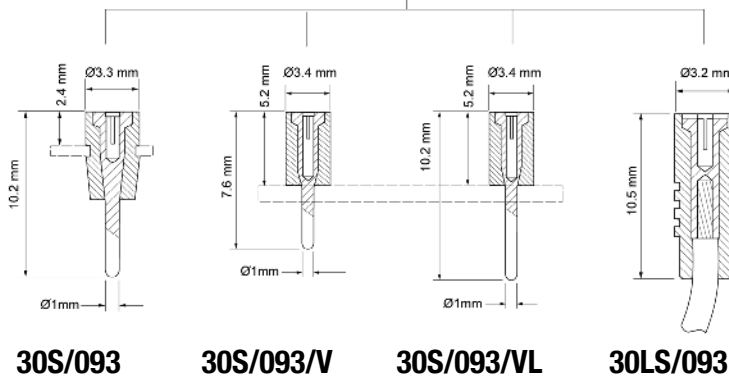
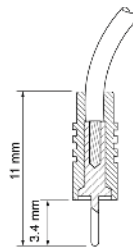

**30S/093**

**30S/093/V**

**30S/093/VL**

**30LS/093**

wires shown for illustration purposes

## [Ordering Information & Dimensions

### 40/50/60 Range

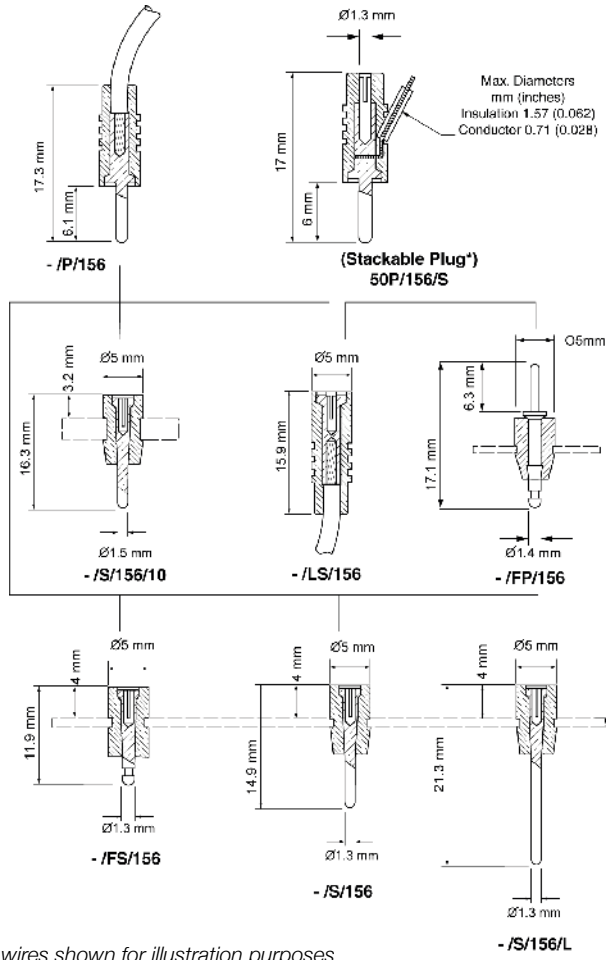

### 100 Range

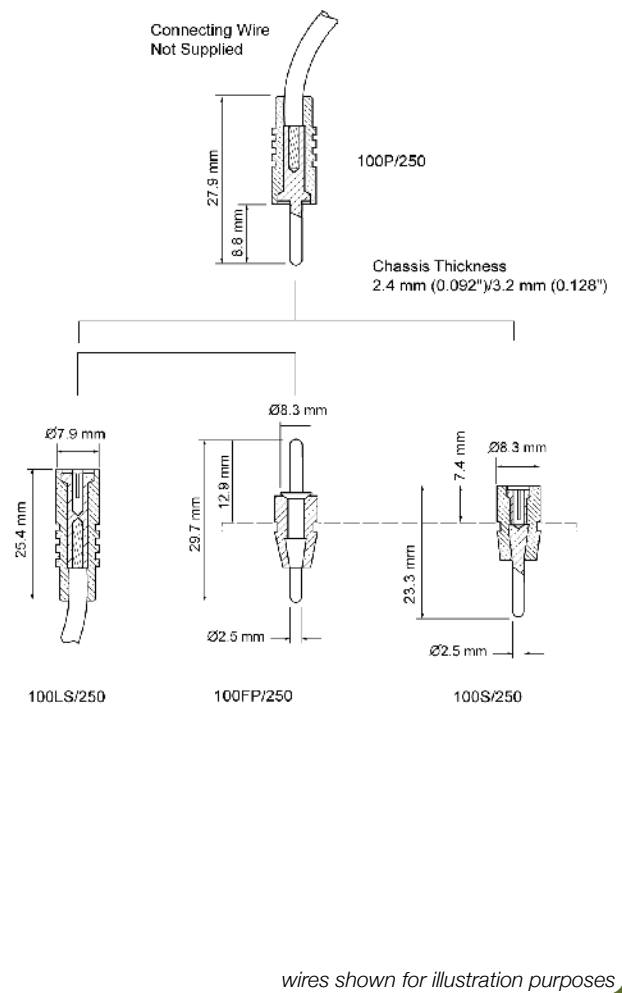

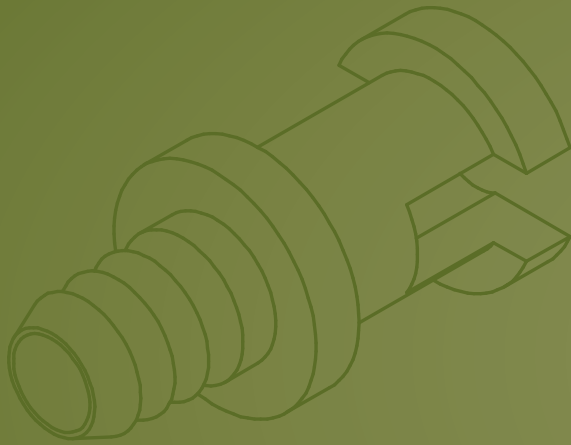

**Oxley Developments Company Ltd**

Priory Park Ulverston Cumbria LA12 9QG United Kingdom  
t: +44 (0) 1229 483226 f: +44 (0) 1229 581851 e: sales@oxleygroup.com

**Oxley Inc**

31 Business Park Drive Branford CT 06405 USA  
t: +1 (203) 488 1033 f: +1 (203) 481 6971 e: info@oxleygroup.com