

# cPCI SERIES

*Ruggedized cPCI (2 mm) Connectors*

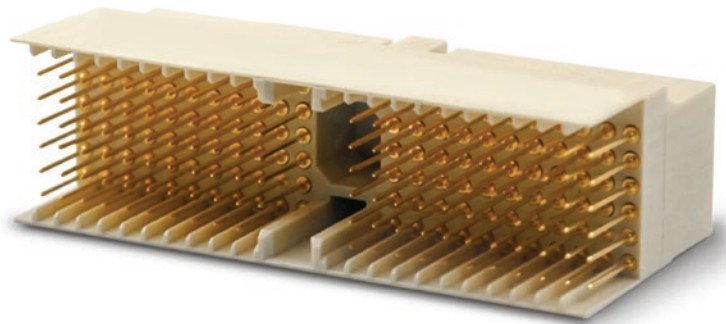
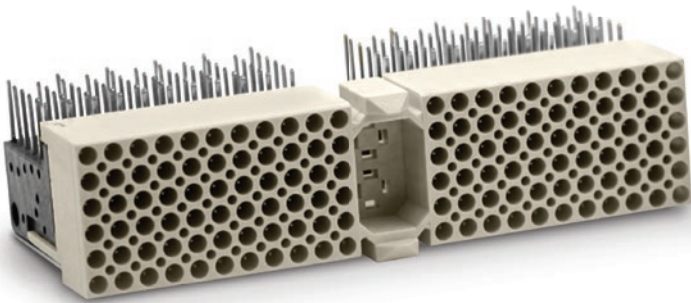

# HYPERBOLOID TECHNOLOGY

Smiths Connectors offers an extensive range of superior contact technologies suitable for standard and custom solutions. Hypertac® (HYPERboloid conTACT) is the original superior performing hyperboloid contact technology designed for use in all applications and in harsh and demanding environments where high reliability and safety are critical. The inherent electrical and mechanical characteristics of the Hypertac hyperboloid contact ensures unrivalled performance in terms of reliability, number of mating cycles, low contact force and minimal contact resistance. The shape of the contact sleeve is formed by hyperbolically arranged contact wires, which align themselves elastically as contact lines around the pin, providing a number of linear contact paths.

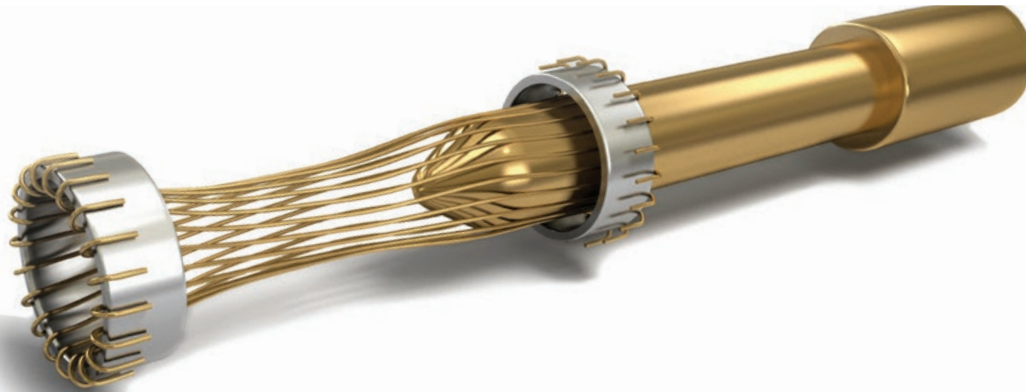

## FEATURES

### LOW INSERTION/EXTRACTION FORCES

The angle of the socket wires allows tight control of the pin insertion and extraction forces. The spring wires are smoothly deflected to make line contact with the pin.

### LONG CONTACT LIFE

The smooth and light wiping action minimizes wear on the contact surfaces. Contacts perform up to 100,000 insertion/extraction cycles with minimal degradation in performance.

### LOWER CONTACT RESISTANCE

The design provides a far greater contact area and the wiping action of the wires insures a clean and polished contact surface. Our contact technology has half the resistance of conventional contact designs.

### HIGHER CURRENT RATINGS

The design parameters of the contact (e.g., the number, diameter and angle of the wires) may be modified for any requirement. The number of wires can be increased so the contact area is distributed over a larger surface. Thus, the high current carried by each wire because of its intimate line contact, can be multiplied many times.

### IMMUNITY TO SHOCK & VIBRATION

The low mass and resultant low inertia of the wires enable them to follow the most abrupt or extreme excursions of the pin without loss of contact. The contact area extends 360 degrees around the pin and is uniform over its entire length. The 3 dimensional symmetry of the Hypertac contact design guarantees electrical continuity in all circumstances.

## BENEFITS

### HIGH DENSITY INTERCONNECT SYSTEMS

Significant reductions in size and weight of sub-system designs. No additional hardware is required to overcome mating and un-mating forces.

### LOW COST OF OWNERSHIP

The Hypertac contact technology will surpass most product requirements, thus eliminating the burden and cost of having to replace the connector or the entire subsystem.

### LOW POWER CONSUMPTION

The lower contact resistance of our technology results in a lower voltage drop across the connector reducing the power consumption and heat generation within the system.

### MAXIMUM CONTACT PERFORMANCE

The lower contact resistance of the Hypertac contact reduces heat build-up; therefore Hypertac contacts are able to handle far greater current in smaller contact assemblies without the detrimental effects of high temperature.

### RELIABILITY UNDER HARSH ENVIRONMENTS

Harsh environmental conditions require connectors that will sustain their electrical integrity even under the most demanding conditions such as shock and vibration. The Hypertac contact provides unmatched stability in demanding environments when failure is not an option.

## FEATURES

- ▶ **Rugged implementation of the Compact PCI Standard**
  - ▶ Fully interchangeable with COTS systems
  - ▶ Reverse gender of commercial 2 mm products
  - ▶ Physical hole pattern in accordance with cPCI PICMG 2.0
  - ▶ Contact identification in accordance with IEC 1076-4 101
- ▶ **Reliable Hypertac® contact technology**
- ▶ **Hi-Rel and NASA GSFC qualified versions**
  - ▶ Only cPCI approved by NASA
  - ▶ LCP insulator meets NASA outgassing requirements
  - ▶ Press-Fit available for receptacle assembly (consult factory)
- ▶ **Available keying feature**
- ▶ **Qualification testing**
  - ▶ cPCI Series meets applicable performance requirements of MIL-DTL-55302, EEE-INST-002, GEVS-SE Rev. A and NASA GSFC S-311-P822 specifications

## BENEFITS

- ▶ **Meets cPCI mechanical footprint and electrical performance specifications**
- ▶ **Modular design for standard 3U/6U configurations**
- ▶ **Highly optimized connector design for high speed data rates, impedance matching and minimal losses**
- ▶ **Durability**
  - ▶ Field proven immunity to shock and vibration
  - ▶ Hyperboloid contact enables 360° self-wiping action
  - ▶ Resistant to fretting corrosion
  - ▶ EMI/RFI shielding
- ▶ **Superior lead traces provide excellent performance in high speed signal applications**
- ▶ **Compatible with standard reflow soldering processes**
- ▶ **Delivers the high reliability essential in military/ aerospace applications**

# cPCI CONNECTOR SERIES

Smiths Connectors' ruggedized 2 mm cPCI Series addresses the market need for a high reliability connector solution which meets the mechanical footprint and electrical performance of the Compact PCI specification. Highly optimized for durability and high speed performance, the cPCI connectors utilize the superior Hypertac hyperboloid contact technology. The 0.4 mm Hypertac contacts in the backplane provide a current rating of 1 A and data rate performance up to 3.125 Gbps with less than 8 mΩ contact resistance. This combined with optimized lead traces provides exception performance in high speed signal applications.

Our connectors have completed and exceeded rigorous testing from NASA for extreme environmental conditions, including thermal excursions, corrosive atmospheres, excessive shock and vibration and contact engagement/separation cycling. As a result, NASA released specification S-311-P-822 naming Smiths Connectors | Hypertac's 2 mm cPCI as the mandated Compact PCI connector in all NASA space flights.

The 2 mm cPCI Series are the high reliability connectors essential in any mission critical applications that are fully interchangeable with Compact PCI COTS systems and IEC 1076-4-101 compliant.

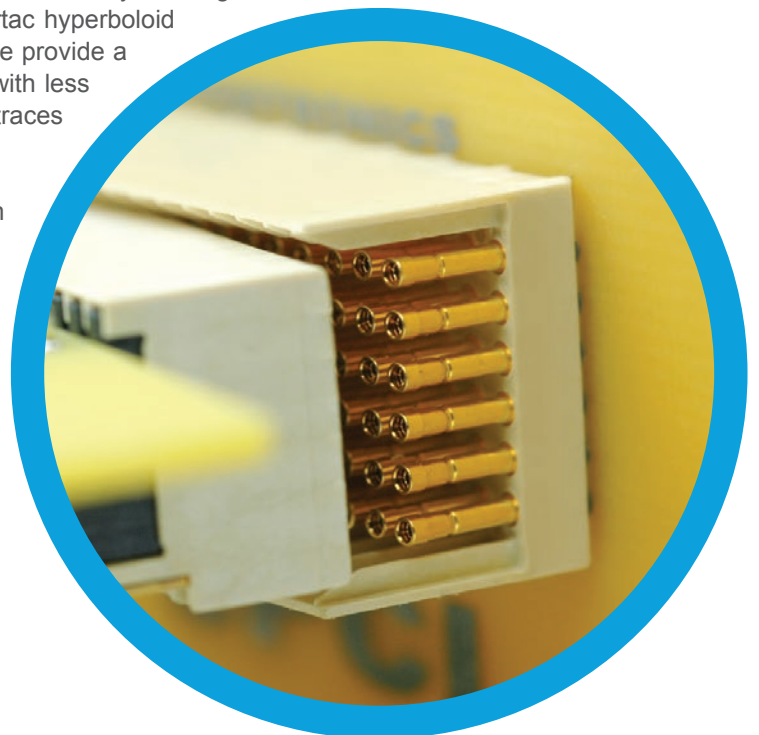

# TECHNICAL CHARACTERISTICS

<b>3U/6U Form Factor</b>	<b>P1/P4</b>	<b>P2/P5</b>	<b>P3</b>	<b>J1/J4</b>	<b>J2/J5</b>	<b>J3</b>
<b>Part Number</b>	K2A110FMD	K2B110FMD	K2B095FMD	K2A110FFD	K2B110FFD	K2B095FFD
<b>Design Criteria</b>	IEC 1076-4 101					
<b>Quality Conformance Inspections</b>	K2 Series: MIL-DTL-55302		311P Series: NASA GSFC S-311-P-822 <sup>(1)</sup>			
<b>Contact Gender</b>	Male Pin			Female Socket		
<b>Contact Spacing</b>	0.079 [2.00]					
<b>Number of Contacts</b>	110 signal, 22 ground		95 signal, 19 ground	110 signal, 22 ground		95 signal, 19 ground
<b>Max. Allowable Gap</b> <i>(Between Mating Connectors)</i>	0.039 [1.00]					
<b>Suggested PCB Hole Diameter</b>	0.28 [0.71] ± 0.002 [0.05] after plating			0.0023 [0.60] mm after plating		

## MATERIALS

<b>Contact Termination</b>	Sold tail: 63/37 tin lead plated	Gold or 63/37 tin lead dipped
<b>Insulation</b>	30% glass filled LCP <i>(meets NASA outgassing specification)</i>	
<b>Contact</b>	Beryllium copper	Beryllium copper socket wires, brass body
<b>Mating Contact</b>	50 µin gold / 50 µin nickel min.	

## MECHANICAL & ENVIRONMENTAL

<b>Temperature Range</b>	-55 to 125° C					
<b>Flammability Range</b>	94 V-O					
<b>Weight</b>	0.55 oz.	0.53 oz.	0.38 oz.	0.38 oz.	0.45 oz.	0.31 oz.
<b>Mating Force</b>	16.38 / 13.20 LBF average per mating connect pair					
<b>Contact Life Cycle</b>	> 4,000 per mated connector pair					
<b>Vibration</b> <i>(Sinusoidal)</i>	Frequency 10 to 2,000 HZ at 15 G (MIL-DTL-55302)(NASA GSFC S311-P-822)					
<b>Vibration</b> <i>(Random)</i>	Fight chassis unit level vibration (NASA Goddard SE Rev 1)					
<b>Mechanical Shock</b>	100 G peak value (NASA GSFC S311-8220)					

## ELECTRICAL

<b>Insulation Resistance</b>	> 5,000 megohms
<b>CRD</b> <i>(Resistance at Rated Current)</i>	4.85 milliohms average
<b>LLCR</b> <i>(Low Level Contact Resistance)</i>	7.20 milliohms average
<b>DWV</b> <i>(Dielectric Withstanding Voltage)</i>	1,000 V RMS

**Notes:**

1) K2 Series: Standard cPCI; 311P Series: NASA Goddard cPCI  
Dimensions are in inches [mm]

# DIMENSIONS

## 2 mm cPCI Series Connectors

### ▶ 2 MM CONNECTOR

Mated Pair

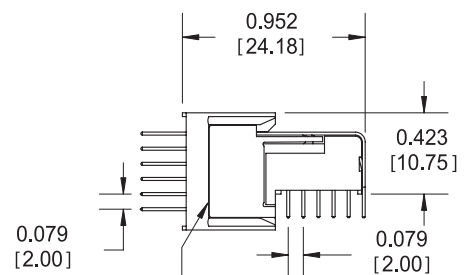
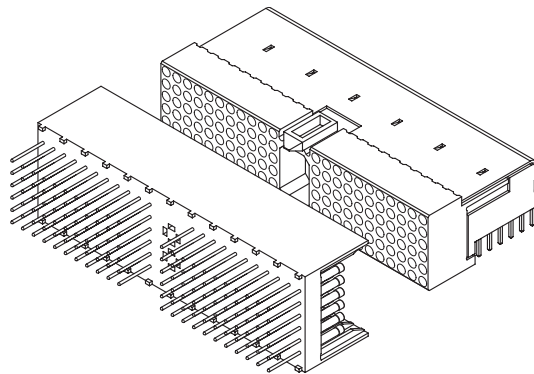
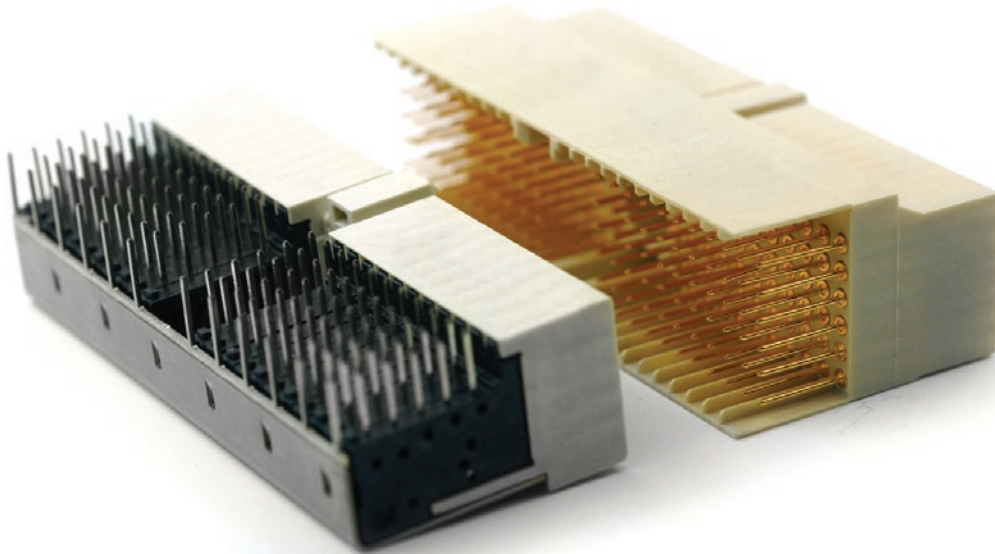

MAXIMUM ALLOWABLE GAP  
BETWEEN MATING SURFACES  
IS 0.039" [1.00mm]

► **K2A MALE**

Part Number K2A110FMDTBH

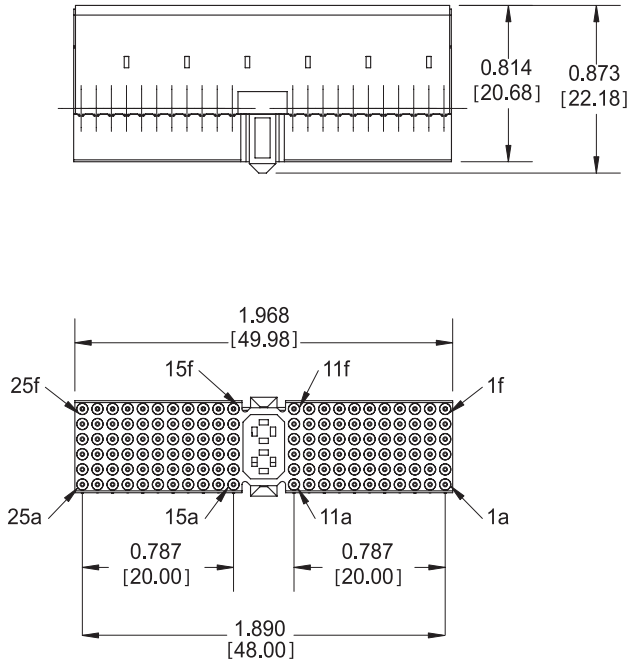

**COMPONENT SIDE OF PCB**

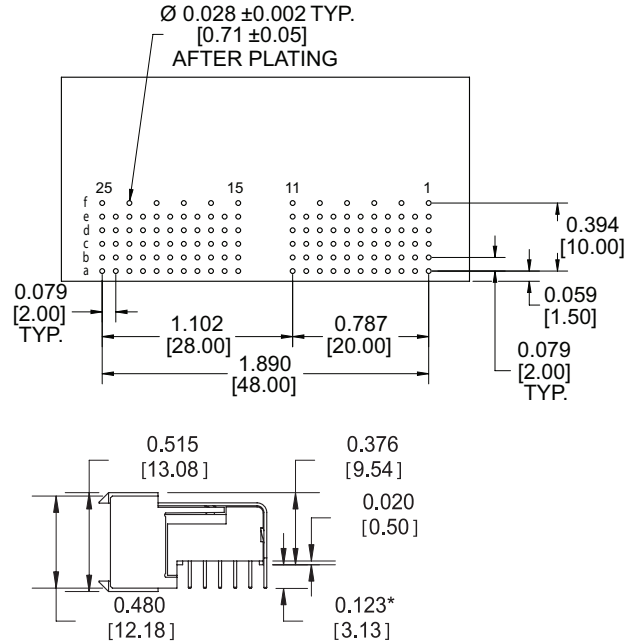

► **K2A FEMALE**

Part Number K2A110FFDTABH

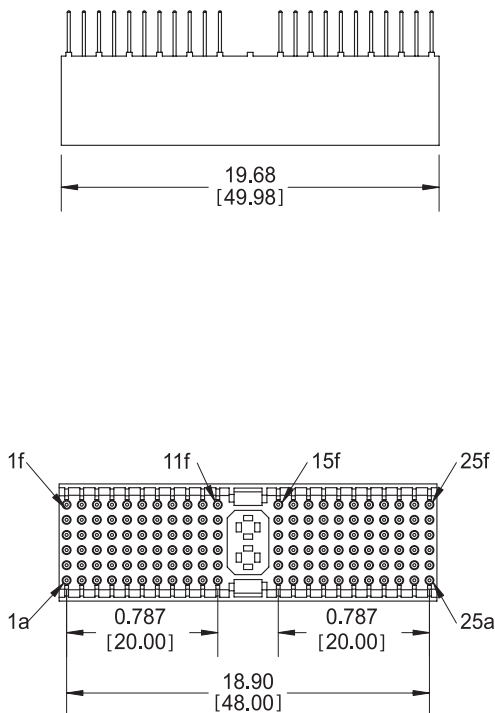

**COMPONENT SIDE OF PCB**

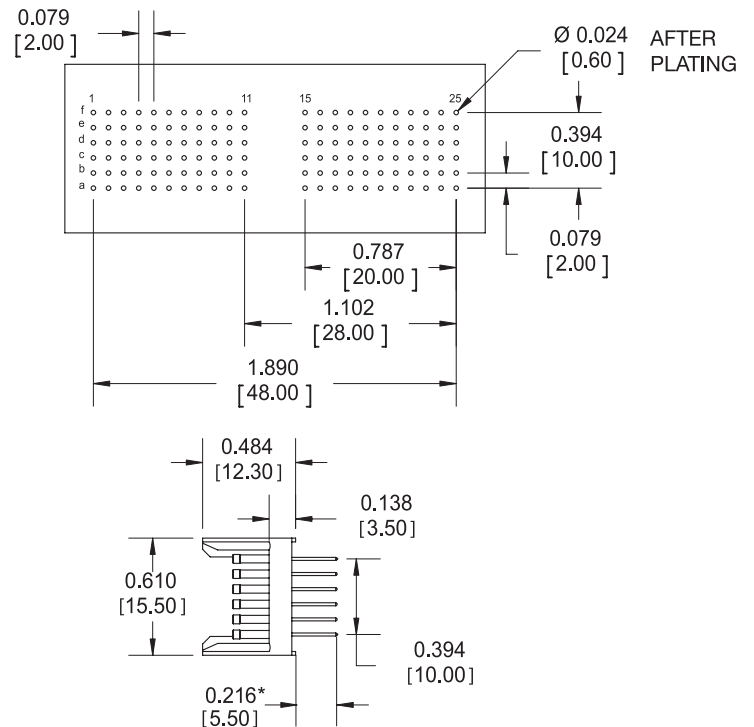

**Notes:**

1) Reference ordering information for additional termination length options  
Dimensions are in inches [mm]

► **K2B MALE**

Part Numbers K2B095FMD & K2B110FMD

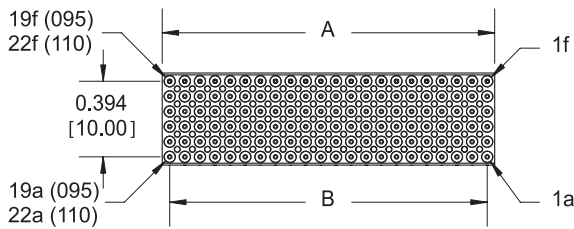
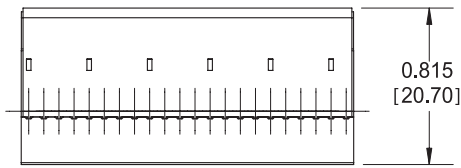

**COMPONENT SIDE OF PCB**

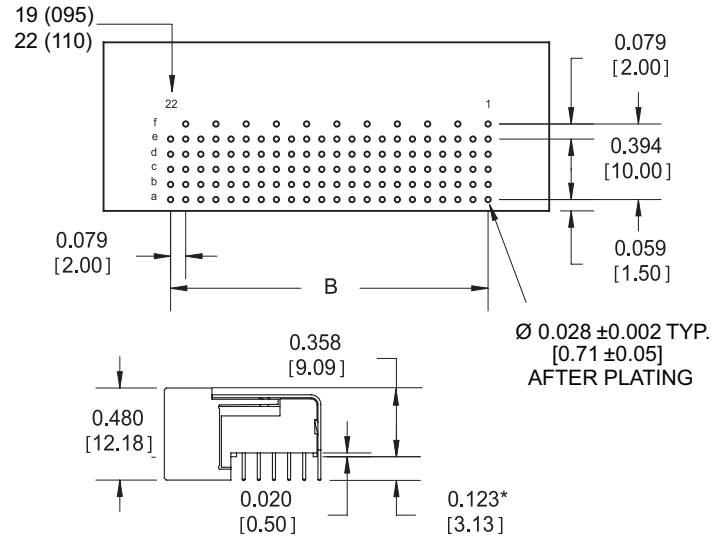

PART NUMBER	A	B
<b>K2B095FMD</b>	1.495 [37.98]	1.417 [36.00]
<b>K2B110FMD</b>	1.731 [43.98]	1.654 [42.00]

► **K2B FEMALE**

Part Numbers K2B095FFD & K2B110FFD

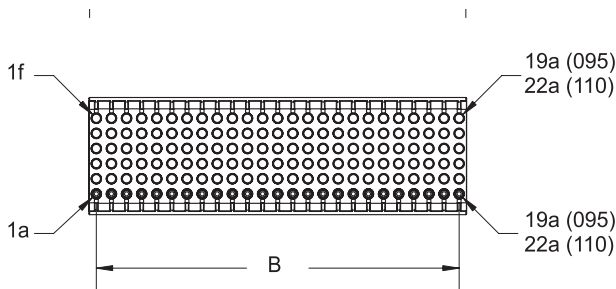
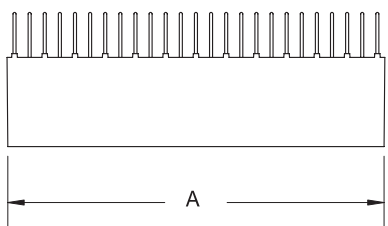

**COMPONENT SIDE OF PCB**

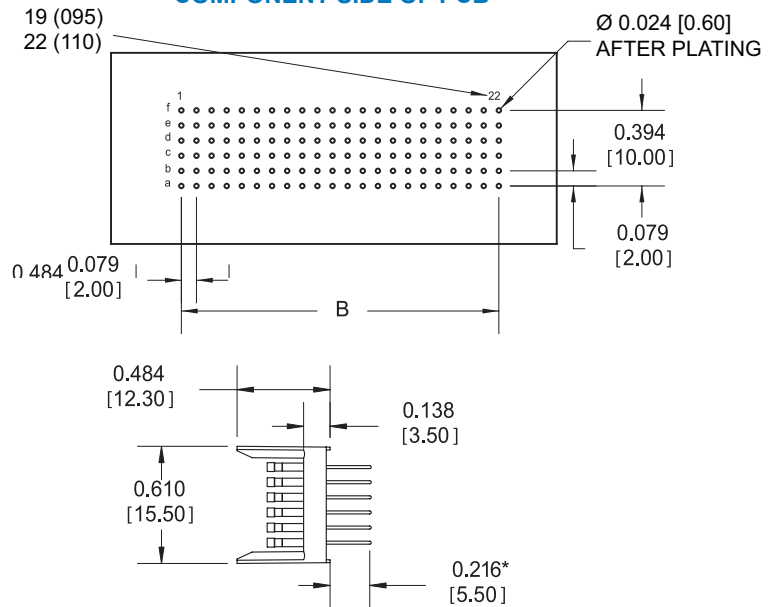

PART NUMBER	A	B
<b>K2B095FFD</b>	1.495 [37.98]	1.417 [36.00]
<b>K2B110FFD</b>	1.731 [43.98]	1.654 [42.00]

**Notes:**

1) Reference ordering information for additional termination length options  
Dimensions are in inches [mm]

# ADAPTERS & FIXTURES

Simple Interfaces for Commercial Test Equipment

## ► ZK2 SOLDER FIXTURES

ZK2 Series solder fixtures prove an economical method for stabilizing the socket contact during the hand soldering and reflow solder process for backplane connectors.

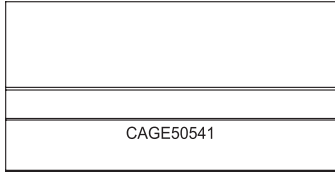

FIXTURE NUMBER	PART NUMBER	A	B
ZK2095-005	K2B095FFDTABH	1.495 [37.98]	1.417 [36.00]
ZK2110-006	K2B110FFDTABH	1.731 [43.98]	1.654 [42.00]
ZK2110-007	K2A110FFDTABH	1.968 [49.98]	1.890 [48.00]

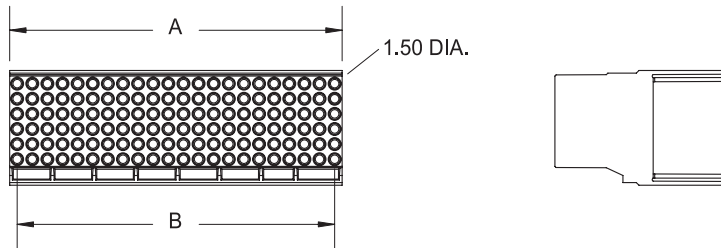

## ► 6U ALIGNMENT TOOLING

ALIGNMENT TOOL	DESCRIPTION	WORK INSTRUCTIONS
T2066	Standard 6U cPCI backplane	S50475
T2082	Standard 6U cPCI daughtercard	S50476

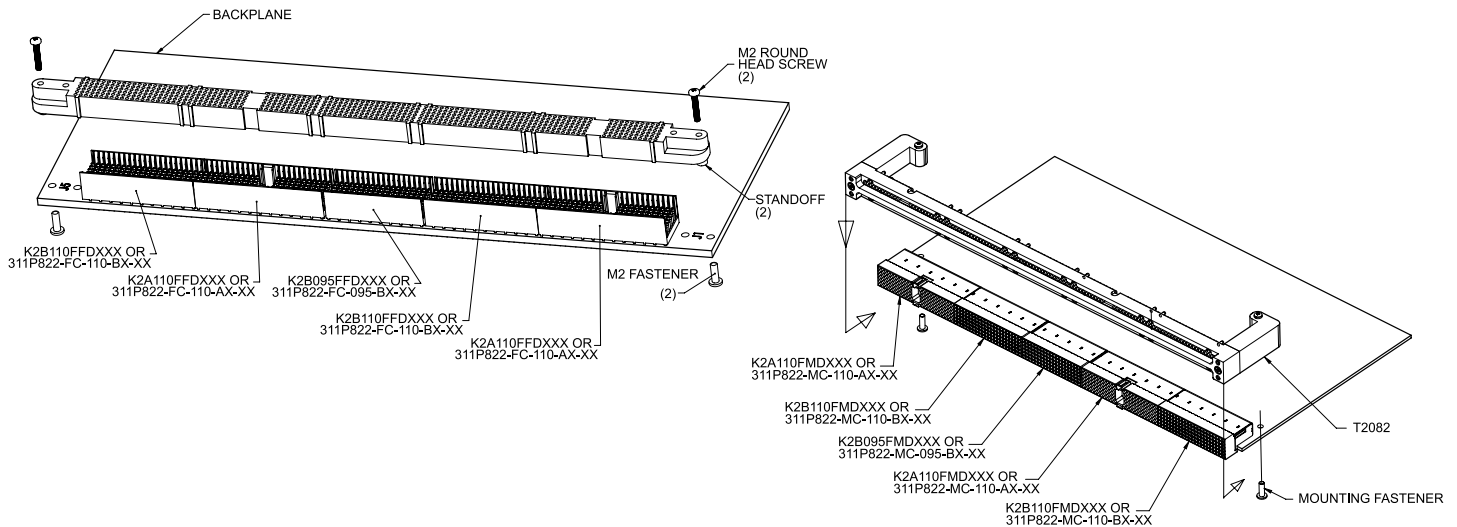



► **K2 MATED TEST ADAPTER**

Part Number K2XXX-0001

Designed to mate a COTS daughter board connector to a Smiths Connectors' mother board connector.

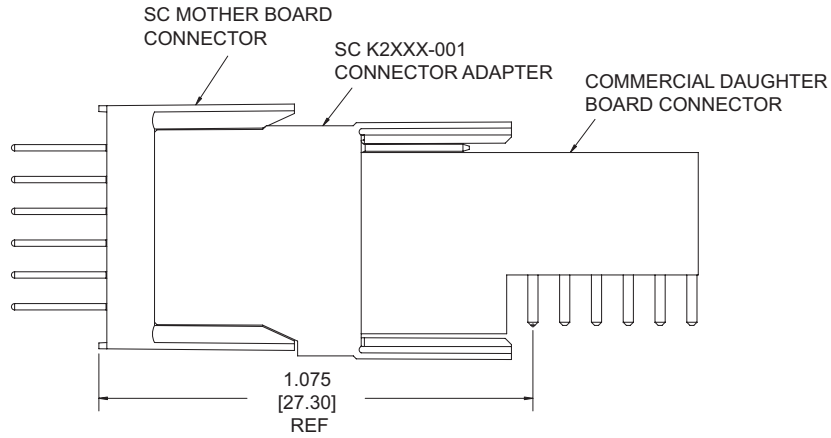

**K2A110-0001**

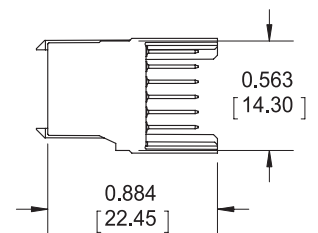
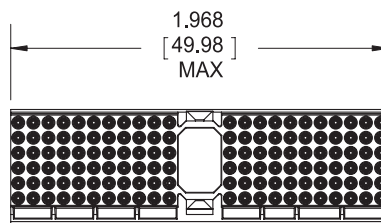
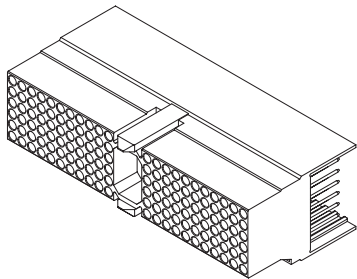

**K2B110-0001**

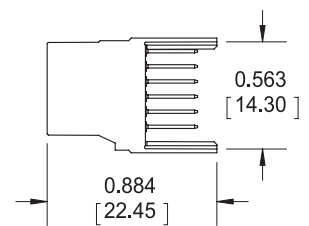
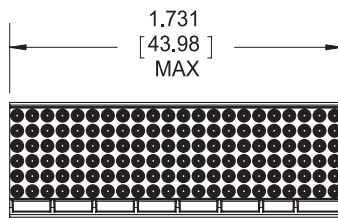
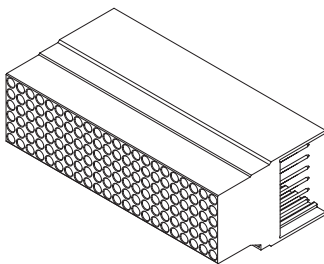

**K2B095-0001**

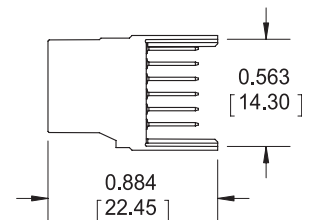
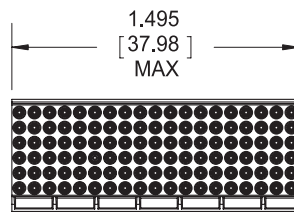
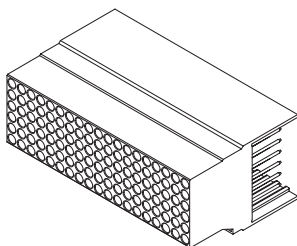

► **K2 MATED TEST ADAPTER**

Part Number K2XXX-0002

Designed to mate a COTS mother board connector to a Smiths Connectors' daughter board connector.

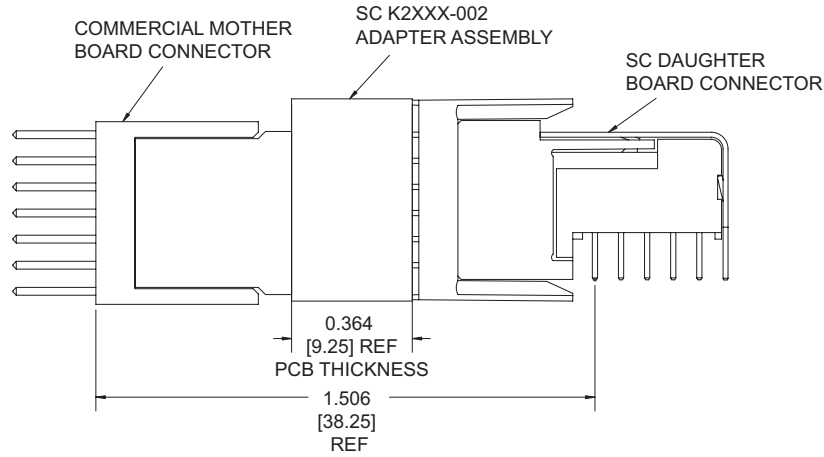

**K2A110-0002**

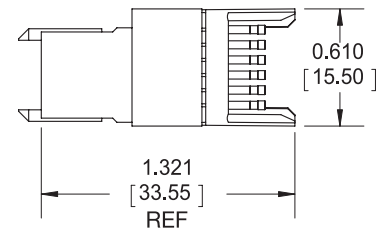
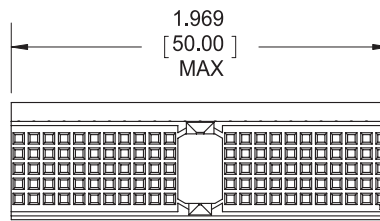
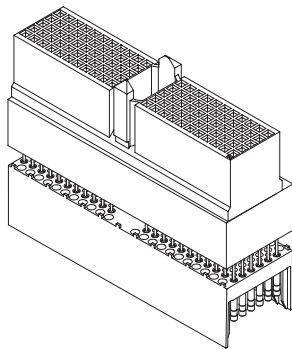

**K2B110-0002**

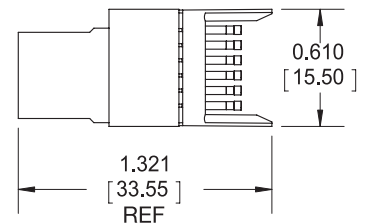
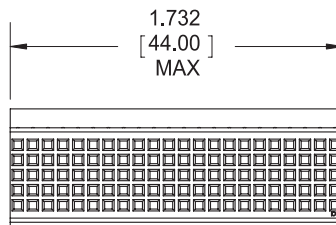
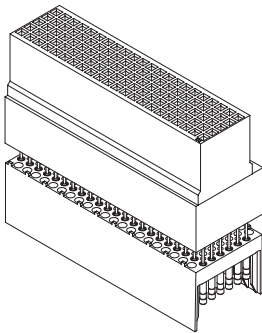

**K2B095-0002**

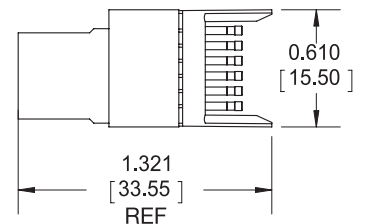
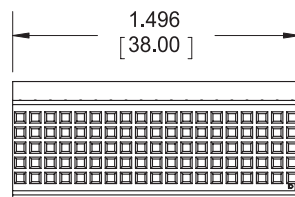
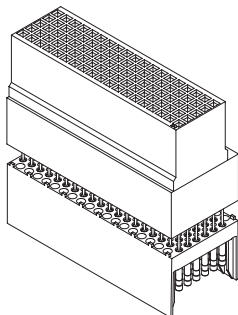

# KEYING OPTION

## User Information

### ► MULTI-PURPOSE CENTER KEYING

#### Options Available

Material: 30% glass filled LCP (meets NASA outgassing requirements)

Color: Natural

EXAMPLE FOR CODE 1348

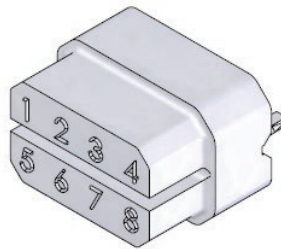
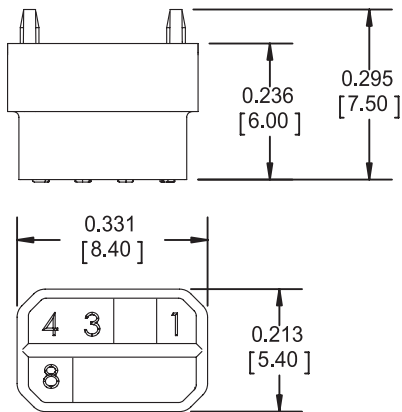

EXAMPLE FOR CODE 2368

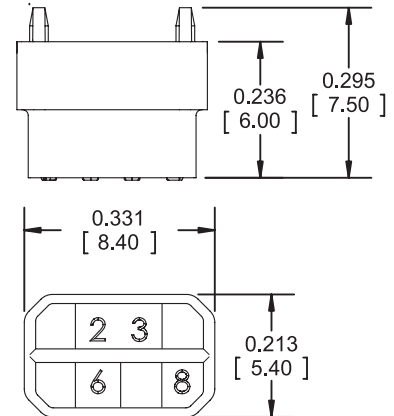

MALE PCB MATCHING CODES MPC KEY PART NUMBER

1234	ZK2000-002-01
1236	ZK2000-002-03
1237	ZK2000-002-04
1238	ZK2000-002-05
1246	ZK2000-002-07
1247	ZK2000-002-08
1268	ZK2000-002-14
1345	ZK2000-002-16
1348	ZK2000-002-19
1357	ZK2000-002-21
1358	ZK2000-002-22
1378	ZK2000-002-25
1457	ZK2000-002-27
1467	ZK2000-002-29
1478	ZK2000-002-31
1568	ZK2000-002-33
1678	ZK2000-002-35
2346	ZK2000-002-37
3467	ZK2000-002-59
3478	ZK2000-002-61
4678	ZK2000-002-69

Intermates with →

FEMALE BACKPLANE MATCHING CODES MPC KEY PART NUMBER

5678	ZK2000-001-01
4578	ZK2000-001-03
4568	ZK2000-001-04
4567	ZK2000-001-05
3578	ZK2000-001-07
3568	ZK2000-001-08
3457	ZK2000-001-14
2678	ZK2000-001-16
2567	ZK2000-001-19
2468	ZK2000-001-21
2467	ZK2000-001-22
2456	ZK2000-001-25
2368	ZK2000-001-27
2358	ZK2000-001-29
2356	ZK2000-001-31
2347	ZK2000-001-33
2345	ZK2000-001-35
1578	ZK2000-001-37
1258	ZK2000-001-59
1256	ZK2000-001-61
1235	ZK2000-001-69

# PERFORMANCE

## ▶ DIFFERENTIAL S-PARAMETER<sup>(1)(2)</sup>

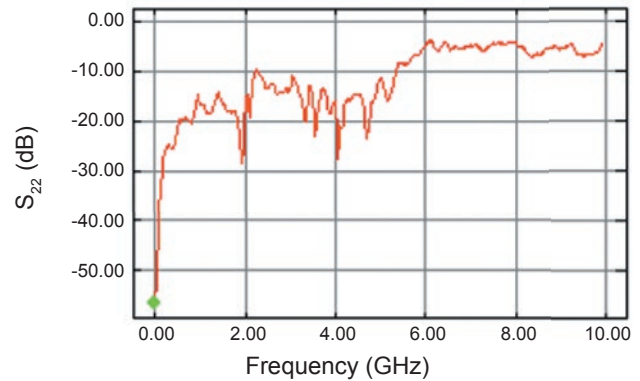
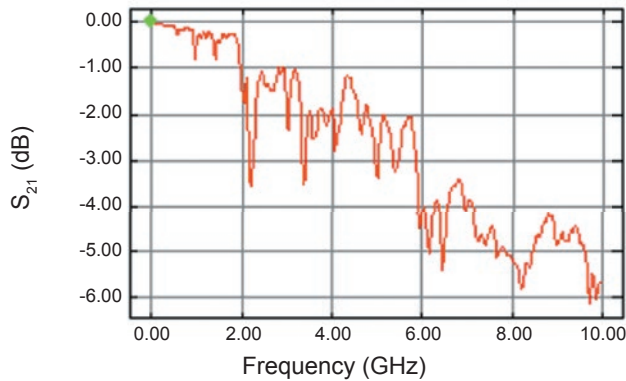
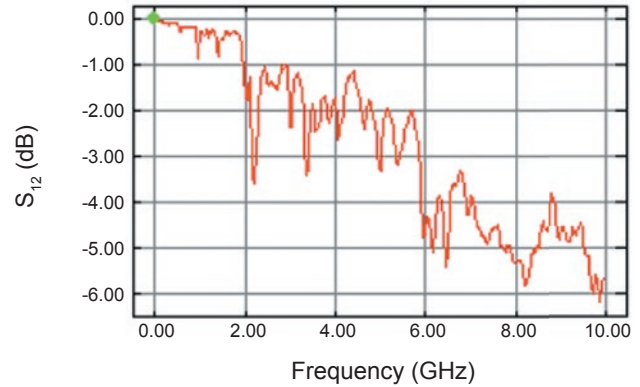
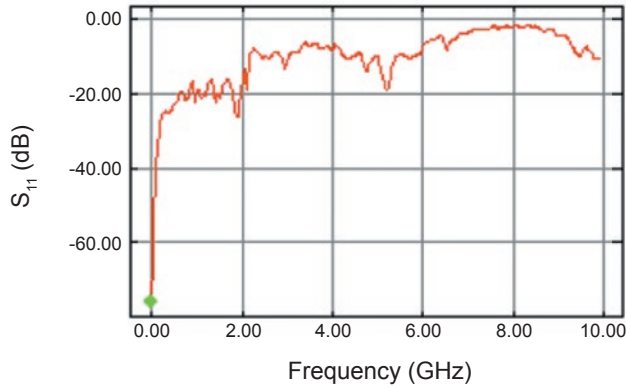

## ▶ PROPAGATION DELAY AND SKEW

Propagation delay through the intrinsic connector assembly is estimated by making a measurement on the reflected signal received on the same broadband fixture that is used to obtain the full vector scattering parameters. In these measurements, there is no inclusion of any other pin lengths other than what is within the intrinsic connector.

PARAMETERS	CONNECTOR ROW				
	A	B	C	D	E
Propagation Delay (ps)	68	90	112	134	156
Skew (ps)	22	22	22	22	22
Maximum Data Rate <sup>2</sup>	3.125 Gb/s				

Notes:

1) Pattern illustrated in the figure on next page was used in the S-parameter and cross talk measurements.

2) Please refer to the full characterization test report for details.

Dimensions are in inches [mm]

► CONNECTOR EYE PATTERN DIAGRAM<sup>(1)(2)</sup>

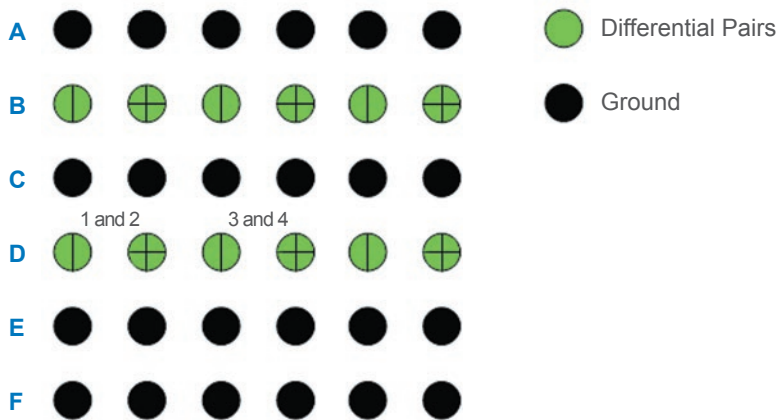
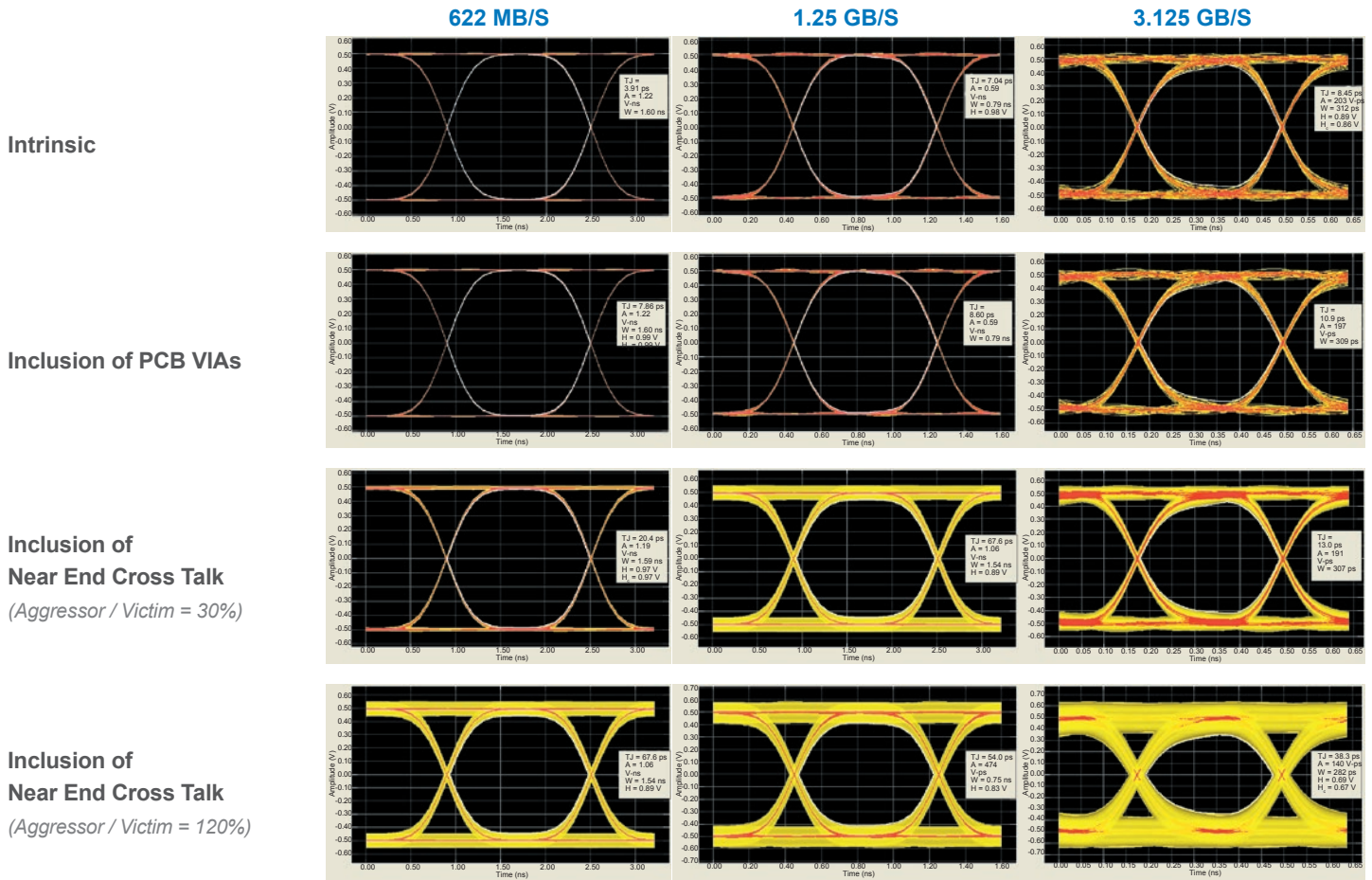

**Notes:**  
 1) Pattern illustrated in the figure on next page was used in the S-parameter and cross talk measurements.  
 2) Please refer to the full characterization test report for details.  
 Dimensions are in inches [mm]

# HOW TO ORDER



## 1 ▶ CONNECTOR FAMILY<sup>(1)</sup> *[Fixed]*

**K2** 2 mm cPCI SERIES

## 2 ▶ CONNECTOR STYLE<sup>(2)</sup> *(Per IEC 1076-4-101)*

**A** WITH MULTI-PURPOSE CENTER (MPC; polarization feature)

**B** WITHOUT MPC

## 3 ▶ NUMBER OF SIGNAL PINS

**110** 110 CONTACTS

**095** 95 CONTACTS

## 4 ▶ NUMBER OF ROWS *[Fixed]*

**F** TOP SHIELD (6 row)

## 5 ▶ CONTACT GENDER

**M** MALE DAUGHTERCARD

**F** FEMALE BACKPLANE

## 6 ▶ STRAIGHT DIP SOLDER

	BACKPLANE CONNECTOR TAIL LENGTH	DAUGHTER BOARD CONNECTOR TAIL LENGTH
<b>D</b>	0.216 [5.50]	0.123 [3.12]
<b>D1</b>	0.380 [9.65]	
<b>D2</b>	0.630 [16.00]	
<b>D4</b>	0.166 [4.22]	0.166 [4.22]
<b>D5</b>	0.265 [6.73]	TBD

## 7 ▶ PLATING

**TAH** 50 µin GOLD OVER NICKEL *(mating surface only)*

OTHER SURFACES GOLD FLASH OVER NICKEL *(female contacts only)*

**TABH** SAME AS TAH WITH TIN/LEAD (63/67) OVER NICKEL ON CONTACT TERMINATIONS *(female contacts only)*

**TBH** SAME AS TH WITH TIN/LEAD (63/67) OVER NICKEL ON CONTACT TERMINATIONS *(male contacts only)*

**Notes:**

1) Quality Conformance Inspection: MIL-DTL 55302 Group A & B

2) Pin one locations per IEC 1076-4-101

Dimensions are in inches [mm]

# HOW TO ORDER | NASA GODDARD

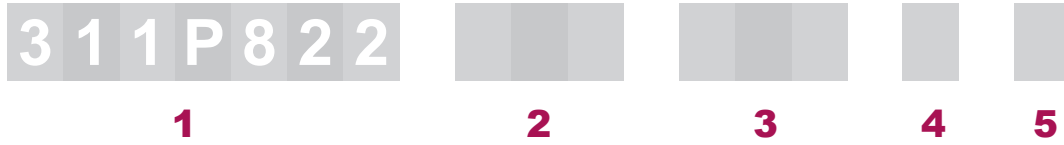

## 1 ▸ GODDARD DESIGNATOR<sup>(1)</sup> [Fixed]

## 2 ▸ CONNECTOR GENDER

- MC** MALE CONNECTOR
- FC** FEMALE CONNECTOR
- MA** MALE ADAPTER
- FA** FEMALE ADAPTER
- FFA** FEMALE-TO-FEMALE ADAPTER

## 3 ▸ NUMBER OF CONTACTS

- 1 1 0** 110 CONTACTS
- 0 9 5** 95 CONTACTS

## 4 ▸ CONNECTOR STYLE

- A** WITH MULTI-PURPOSE CENTER (MPC; polarization feature)
- B** WITHOUT MPC

### SOLDER TAIL FINISH

- G** GOLD FLASH OVER NICKEL
- S** 63/37 TINE/LEAD SOLDER OVER NICKEL

## 5 ▸ SOLDER TAIL LENGTH

	BACKPLANE CONNECTOR TAIL LENGTH	DAUGHTER BOARD CONNECTOR TAIL LENGTH
<b>D</b>	0.216 [5.50]	0.123 [3.12]
<b>D 1</b>	0.380 [9.65]	
<b>D 2</b>	0.630 [16.00]	
<b>D 4</b>	0.166 [4.22]	0.166 [4.22]
<b>D 5</b>	0.265 [6.73]	TBD

Notes:  
 1) Quality Conformance Inspection: NASA GSFC S-311-P-822 Table II  
 Dimensions are in inches [mm]



# SMITHS CONNECTORS GLOBAL SUPPORT

## AMERICAS

[info.us@smithsconnectors.com](mailto:info.us@smithsconnectors.com)

### Costa Mesa, CA

1.714.371.1100

### Hudson, MA

1.978.568.0451

### Kansas City, KS

1.913.342.5544

## EUROPE

### France

33.2.32969176

[info.fr@smithsconnectors.com](mailto:info.fr@smithsconnectors.com)

### Germany

49.991.250.120

[info.de@smithsconnectors.com](mailto:info.de@smithsconnectors.com)

### Italy

39.010.60361

[info.it@smithsconnectors.com](mailto:info.it@smithsconnectors.com)

### United Kingdom

44.208.236.2400

[info.uk@smithsconnectors.com](mailto:info.uk@smithsconnectors.com)

## ASIA

[asiainfo@smithsconnectors.com](mailto:asiainfo@smithsconnectors.com)

### Shanghai, China

86.21.3318.4650

### Suzhou, China

86.512.6273.1188

### Singapore

65.6846.1655

visit us at | [smithsconnectors.com](http://smithsconnectors.com) |     